

Alaska Scientific Crime Detection Laboratory

DataMaster Certification Form

Issued: 04/04/2012
Effective: 04/04/2012

Version: DMCEF2012 R1
Status: Active

Instrument S/N 100390 Analyst CRF Start Date 4/27/12

Diagnostic Test (attached)

1. Voltage Checks

a. Adjust voltages, if needed

i. Lamp (2.6V Maximum)

ii. Bias (80V)

iii. Cooler (2.0V Maximum)

iv. Chopper Frequency

v. Detector Voltage (-0.100V to 0.100V)

b. Set RFI

c. Adjust barometer reading to match NIST traceable barometer

d. Adjust volume setting, if needed (1.5L +/- 0.1L)

e. Print Technician Screen (attached)

2. Print Calibration Factors (attached)

3. Volume Test - Minimum 1600 mL (1.3L to 1.7L)

4. Linearity Test (attached)

a. Levels Used

i. 0.020g/210L Mnf ILMO Lot 07611020A5 Exp 3/1/13

ii. 0.040g/210L Mnf ILMO Lot 07611040A4 Exp 3/1/13

iii. 0.080g/210L Mnf ILMO Lot 02012080A1 Exp 3/1/14

iv. 0.100g/210L Mnf ILMO Lot 0761100A3 Exp 3/1/13

v. 0.200g/210L Mnf Guth Lot 11120 Exp 7/19/13

1. Simulator S/N SD1176 Date Calibrated 8/17/11

vi. 0.300g/210L Mnf Guth Lot 11110 Exp 7/13/13

1. Simulator S/N DR4176 Date Calibrated 2/21/12

5. Functional Tests (attached)

a. Incomplete

b. Invalid

c. Interference

i. Acetone - Mnf Guth Lot 11200 Level 0.080 Exp 10/11/13

1. Simulator S/N SD1199 Date Calibrated 1/11/12

ii. Isopropanol - Mnf Guth Lot 10280 Level 0.080 Exp 11/17/12

1. Simulator S/N DR6267 Date Calibrated 1/10/12

iii. Negative Control - Mnf Guth Lot 11250 Level 0.100 Exp 12/6/13

1. Simulator S/N SD1202 Date Calibrated 8/17/11

d. RFI

6. Verify stylus is calibrated

7. Verify card reader is functional

8. Reset Options

9. Clear Memory

10. Verification of Calibration

11. Non-Drinking Subject Test (attached)

12. Upload

13. Update agency information and polling status in DM Host Calling Program NA

End Date 4/30/12

DIAGNOSTIC RECORD

Alaska Department of Public Safety
DATANASTER dmt: 100390

Date: 04/27/2012
Time: 10:55:50

VERSIONS

DMT: 2.00
PIC: 3.02
Modem: 2.3
Questions: 2.2

TEMPERATURES

Sample Chamber = 48.9°C PASSED
Breath Tube = 47.0°C PASSED

PUMP INFO

Flow Rate = 5.528 L/M PASSED

DETECTOR INFO

PUMP ON PASSED
PUMP OFF PASSED

FILTER INFO

Filter 1 PASSED
Filter 2 PASSED
Filter 3 PASSED

INTERNAL STANDARD PASSED

2/19
LF

Technician Screen

DATAMASTER dmt: 100390

Date: 04/27/2012
Time: 11:26 AM

Temperatures (°C)
Sample Cell: 49.5°C
Breath Tube: 46.6°C

Current Barometer 29.6 in
Volume (Ltr) 1.48

Settings
Lamp: 1.62 V
Bias: 80 V
Cooler: 1.65 V
Chopper: 544 Hz

Voltages (V)
Flow: 1.06 V
Detector: 0.058 V

3/19
WF

CALIBRATION FACTORS

Alaska Department of Public Safety
DATAMASTER dmt: 100390

Date: 03/10/2011
Time: 07:44:47

Ga = 0.1000
CAL = 0.993918 0.800 <= CAL < 1.200
b1 = 0.0005 0.0000 <= b1 < 0.0040
b2 = 0.0038 0.0010 <= b2 < 0.0100
b3 = 0.0003 0.0000 <= b3 < 0.0040
Xg = 0.0958 0.0500 <= Xg < 0.2000
a21 = 1.168537 1.050 <= a21 < 1.300
a31 = 0.503509 0.300 <= a31 < 0.800

4/19
WF

SUBJECT TEST

Alaska Department of Public Safety
DAVIDMASTER dmc: 100390

Date: 04/27/2012
Time: 13:26:37

SUBJECT NAME:
TEST TEST
LICENSE #: XXXX

OPERATOR NAME:
MINIMUM VOLUME
OPERATOR'S #: XXXX

DEPT/AGENCY:
XXXX
CASE/REPORT: XXXX
TEST TYPE: TEST

EXTERNAL STANDARD INFORMATION

NOMINAL: 0.080
TARGET AT 29.55: 0.079
LOT #: 07511080A1
EXPIRATION: 03/01/2013

DIAGNOSTIC CHECK	PASSED	13:32
BLANK TEST	0.000	13:33
INTERNAL STANDARD	VERIFIED	13:33
EXTERNAL STANDARD	0.081	13:33
BLANK TEST	0.000	13:34
SUBJECT SAMPLE	0.000	13:35
BLANK TEST	0.000	13:36
EXTERNAL STANDARD	0.081	13:36
BLANK TEST	0.000	13:37

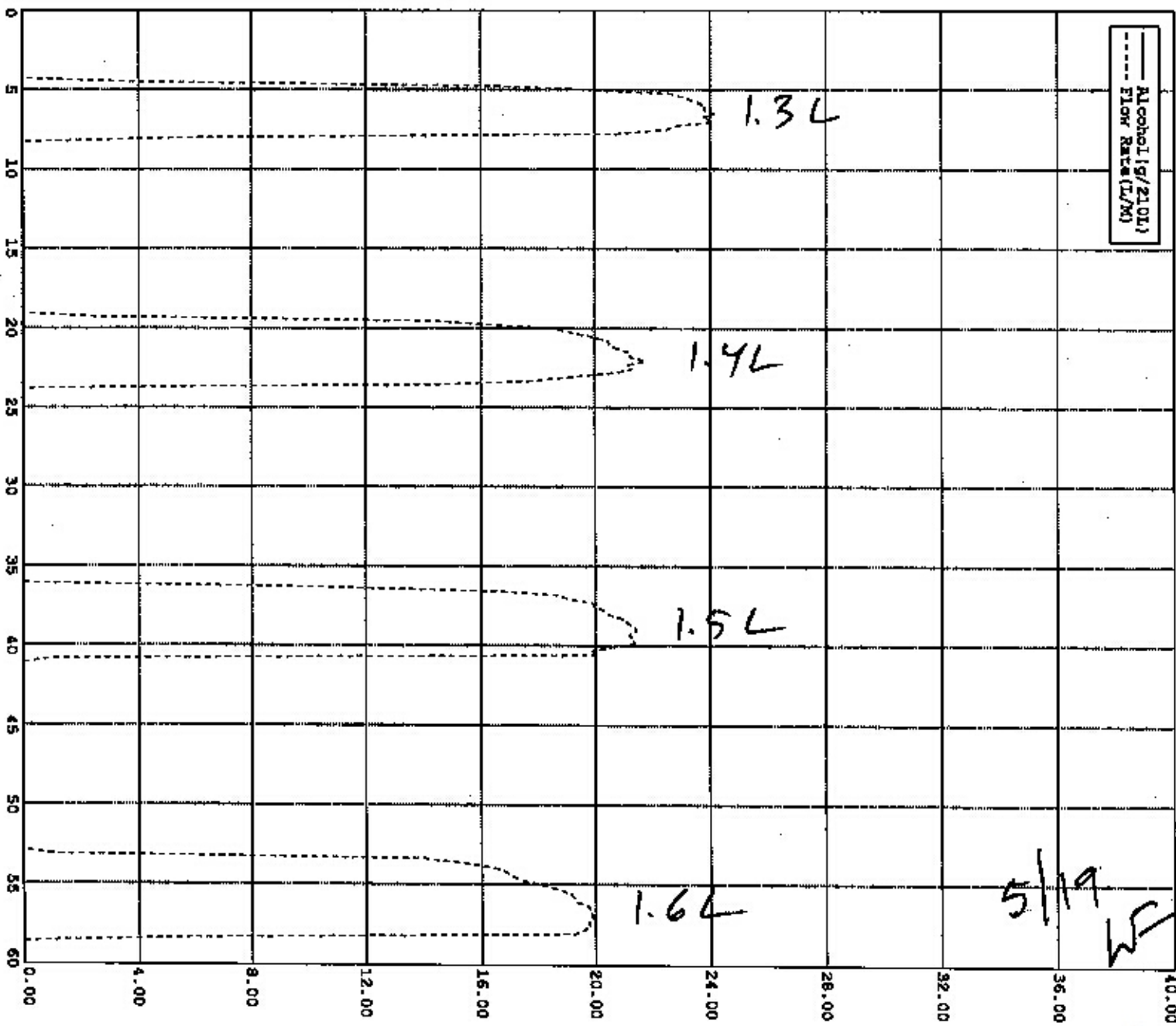

LINEARITY CHECK

Alaska Department of Public Safety
 DATANUMBER dno: 100390

Date: 04/27/2012
 Time: 14:29:29

SUPERVISOR NAME:
 CHARLES FOSTER
 OPERATOR'S #: 7734

TARGET	AVERAGE	STD. DEV.
0.019	0.0211	0.0003
0.039	0.0406	0.0004
0.079	0.0808	0.0002
0.098	0.1009	0.0006
0.200	0.2049	0.0003
0.300	0.3059	0.0007

SLOPE = 1.016062
 R² = 0.999981

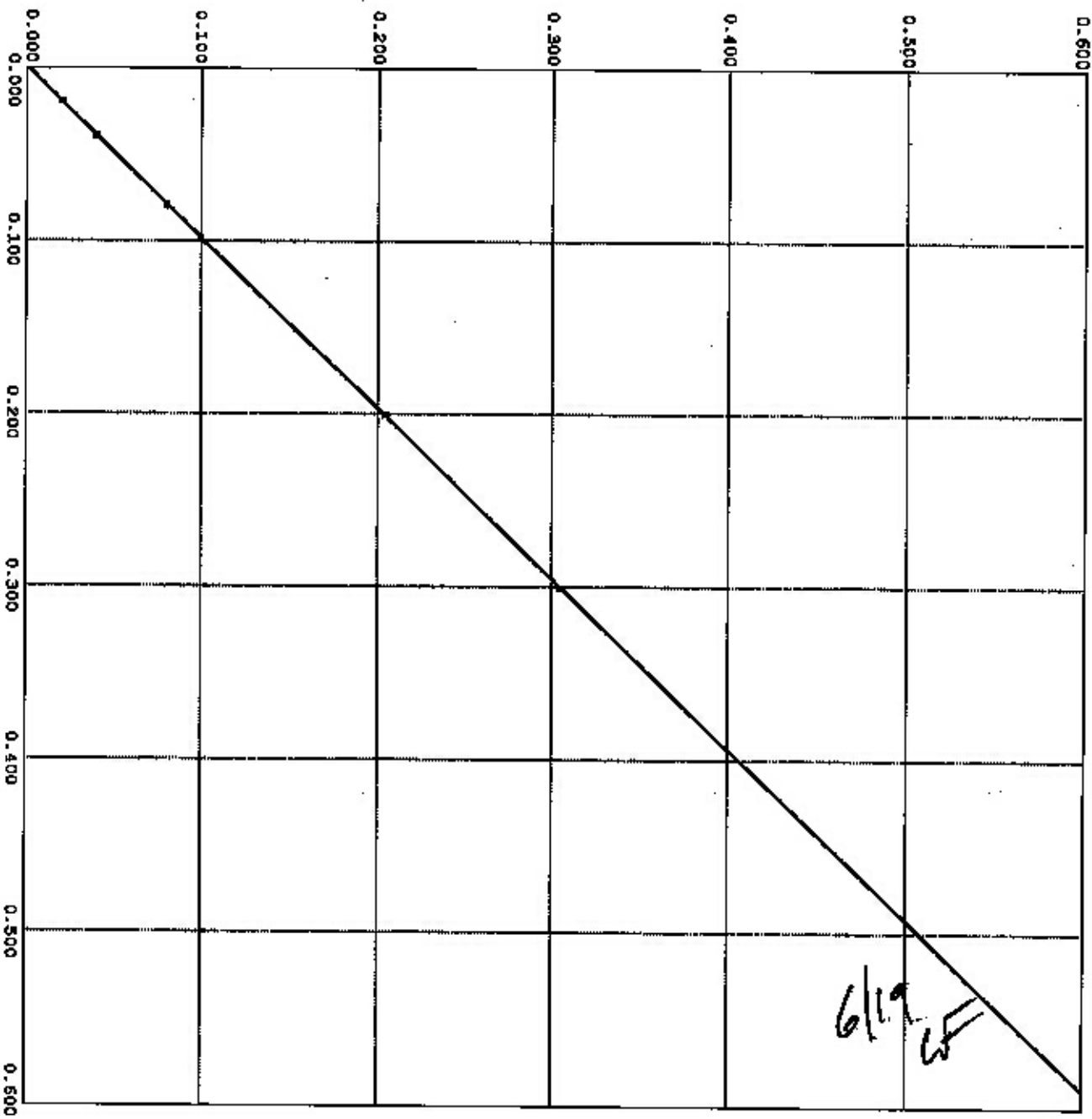

LINEARITY CHECK: Control Test 1

Alaska Department of Public Safety
 DATAMASTER dmt: 100390

Date: 04/27/2012
 Time: 14:29:31

EXTERNAL STANDARD INFORMATION
 NOMINAL: 0.020
 TARGET AT 29.55: 0.019
 LOT #: 07611020A5
 EXPIRATION: 03/01/2013

BLANK TEST	0.000	14:38
INTERNAL STANDARD	VERIFIED	14:38
EXTERNAL STANDARD	0.021	14:39
BLANK TEST	0.000	14:40
EXTERNAL STANDARD	0.021	14:40
BLANK TEST	0.000	14:41
EXTERNAL STANDARD	0.020	14:41
BLANK TEST	0.000	14:42
EXTERNAL STANDARD	0.021	14:42
BLANK TEST	0.000	14:43
EXTERNAL STANDARD	0.020	14:43
BLANK TEST	0.000	14:44

Average = 0.0211
 Std Dev = 0.0003

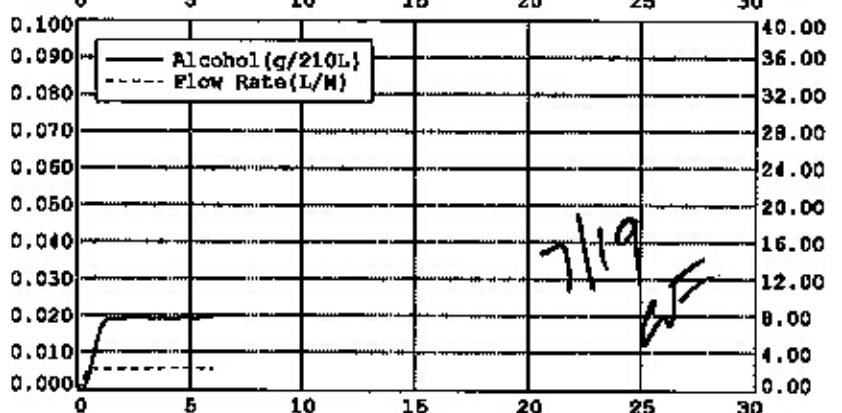
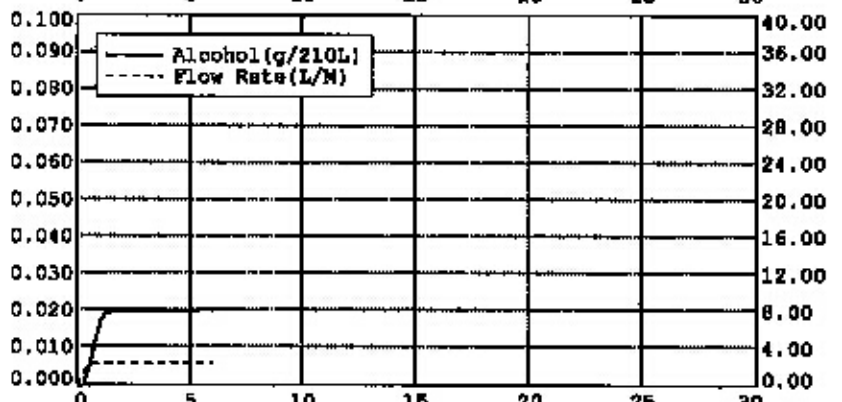
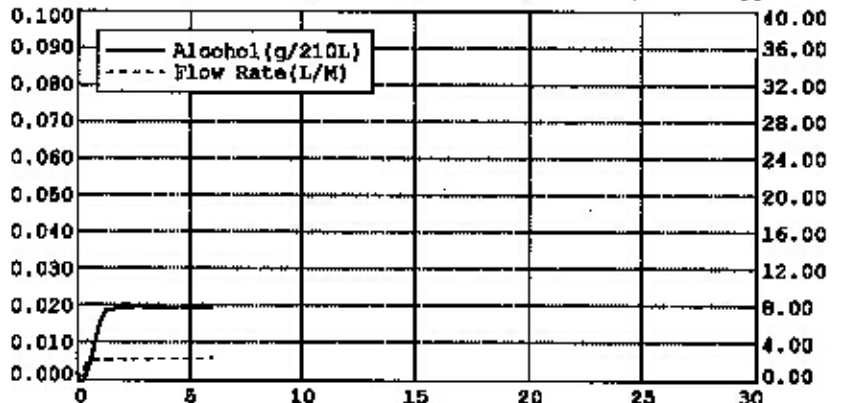
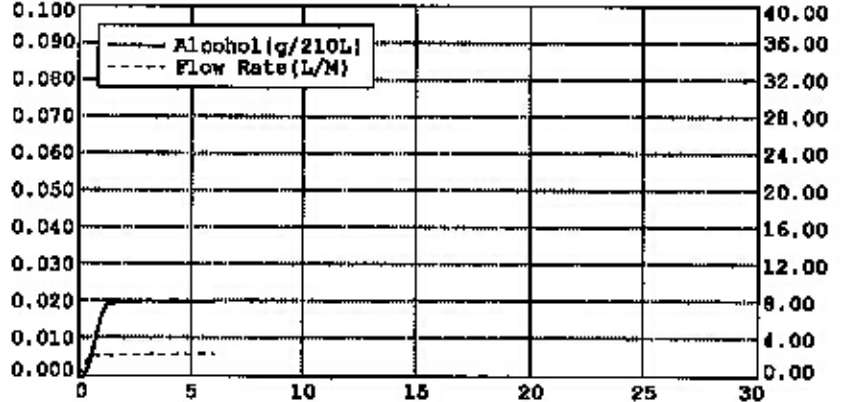
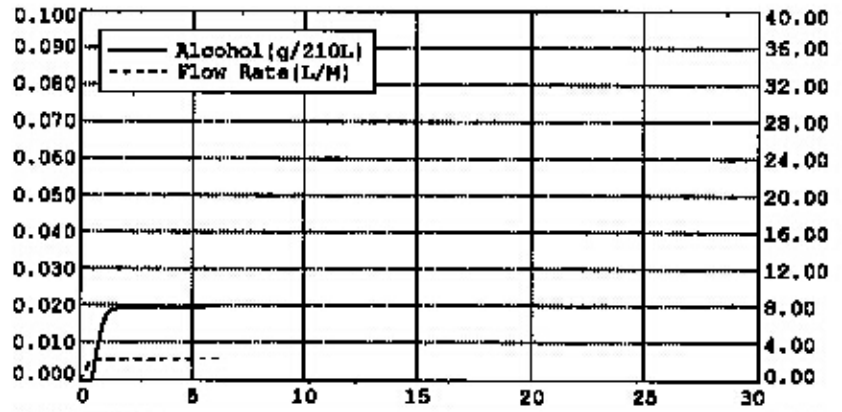

LINEARITY CHECK: Control Test 2

Alaska Department of Public Safety
 DATAMASTER dnt: 100390

Date: 04/27/2012
 Time: 14:46:24

EXTERNAL STANDARD INFORMATION
 NOMINAL: 0.040
 TARGET AT 29.55: 0.039
 LOT #: 07611040A4
 EXPIRATION: 03/01/2013

BLANK TEST	0.000	14:48
INTERNAL STANDARD	VERIFIED	14:48
EXTERNAL STANDARD	0.040	14:48
BLANK TEST	0.000	14:49
EXTERNAL STANDARD	0.041	14:50
BLANK TEST	0.000	14:50
EXTERNAL STANDARD	0.040	14:51
BLANK TEST	0.000	14:52
EXTERNAL STANDARD	0.040	14:52
BLANK TEST	0.000	14:53
EXTERNAL STANDARD	0.040	14:53
BLANK TEST	0.000	14:54

Average = 0.0406
 Std Dev = 0.0004

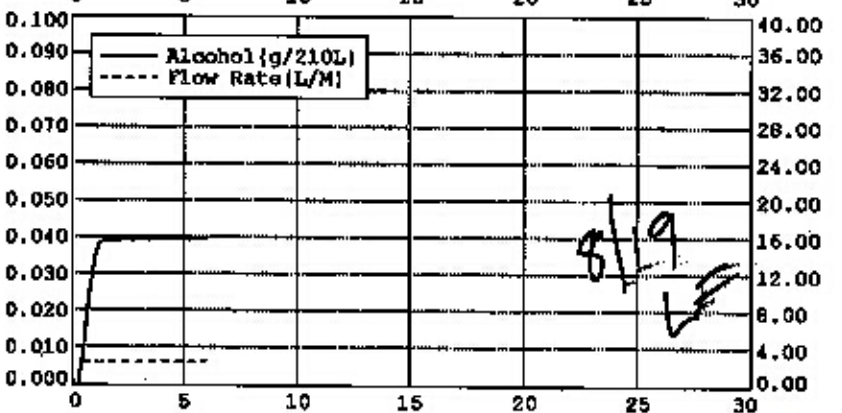
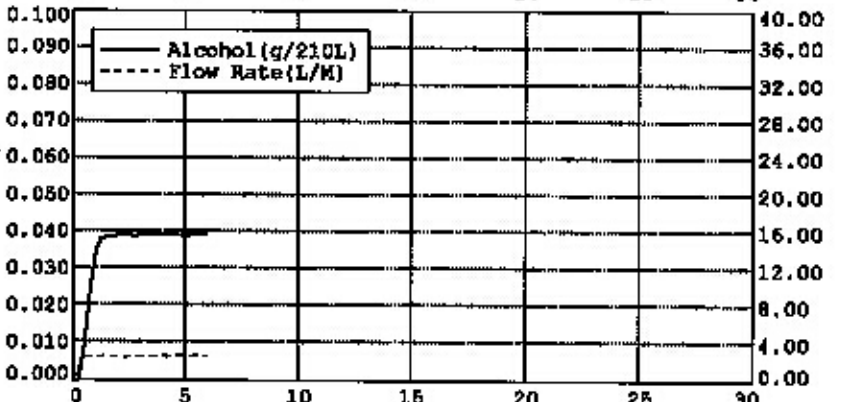
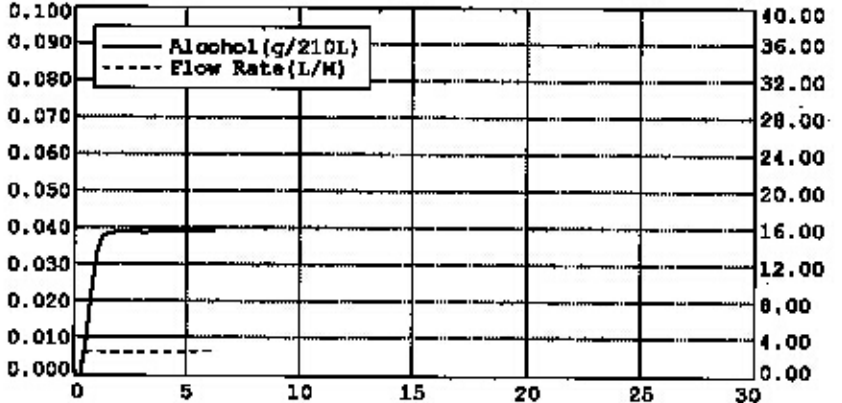
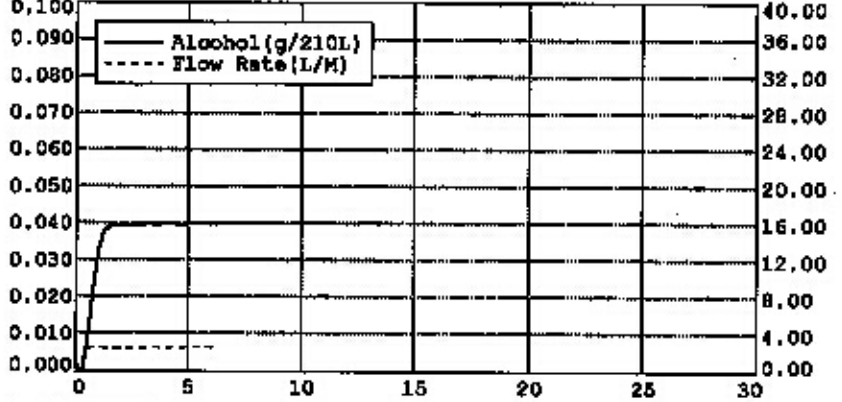
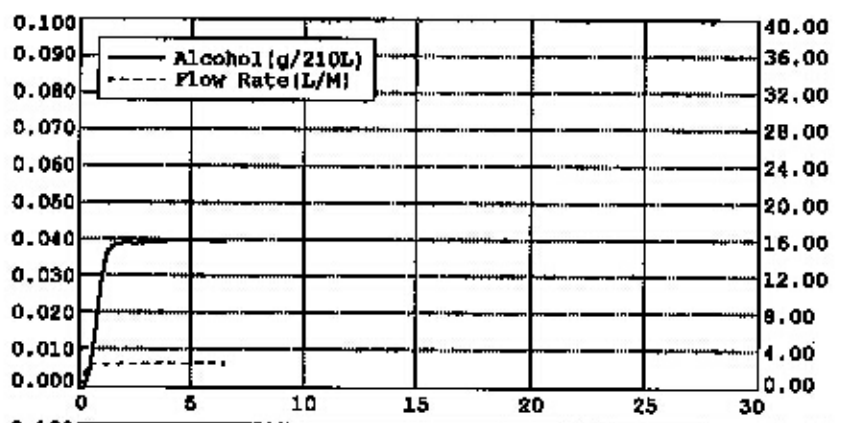

LINEARITY CHECK: Control Test 3

Alaska Department of Public Safety
 DATAMASTER dnt: 100390

Date: 04/27/2012
 Time: 14:58:31

EXTERNAL STANDARD INFORMATION
 NOMINAL: 0.080
 TARGET AT 29.55; 0.079
 LOT #: 02012080A1
 EXPIRATION: 03/01/2014

BLANK TEST	0.000	14:59
INTERNAL STANDARD	VERIFIED	14:59
EXTERNAL STANDARD	0.080	15:00
BLANK TEST	0.000	15:00
EXTERNAL STANDARD	0.080	15:01
BLANK TEST	0.000	15:02
EXTERNAL STANDARD	0.080	15:02
BLANK TEST	0.000	15:03
EXTERNAL STANDARD	0.080	15:03
BLANK TEST	0.000	15:04
EXTERNAL STANDARD	0.080	15:04
BLANK TEST	0.000	15:05

Average = 0.0808
 Std Dev = 0.0002

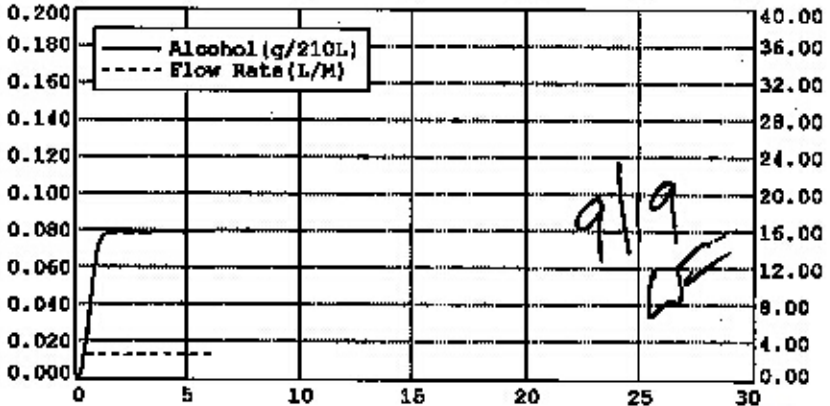
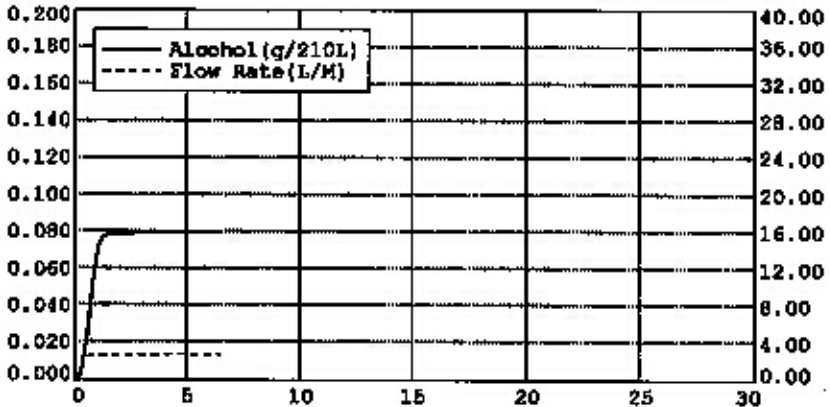
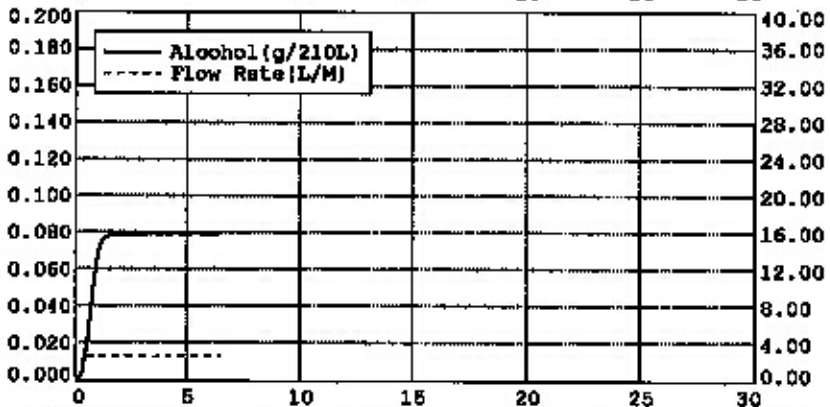
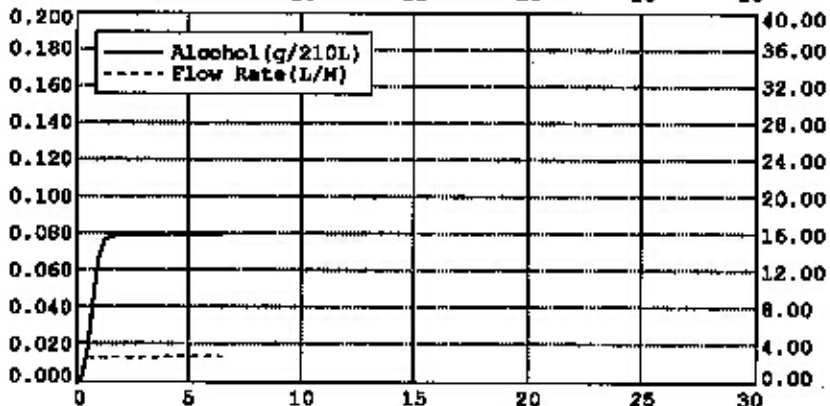
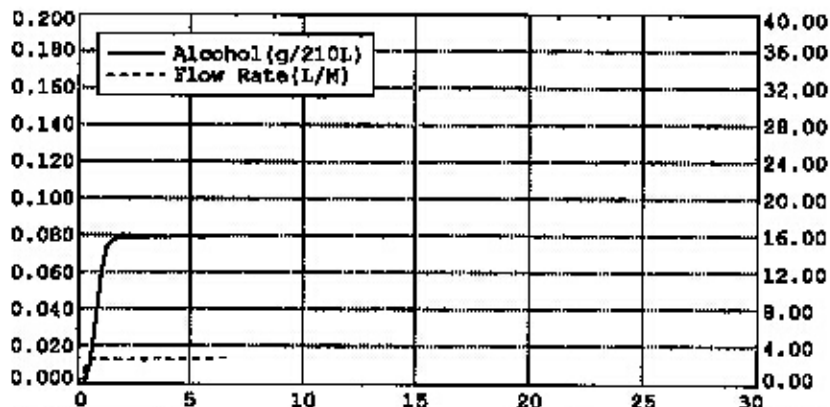

LINEARITY CHECK; Control Test 4

Alaska Department of Public Safety
DATAMASTER dnt; 100390

Date: 04/27/2012
Time: 15:07:27

EXTERNAL STANDARD INFORMATION

NOMINAL: 0.100
TARGET AT 29.55: 0.098
LOT #: 07611100A3
EXPIRATION: 03/01/2013

BLANK TEST	0.000	15:09
INTERNAL STANDARD	VERIFIED	15:09
EXTERNAL STANDARD	0.101	15:09
BLANK TEST	0.000	15:10
EXTERNAL STANDARD	0.100	15:10
BLANK TEST	0.000	15:11
EXTERNAL STANDARD	0.100	15:11
BLANK TEST	0.000	15:12
EXTERNAL STANDARD	0.100	15:12
BLANK TEST	0.000	15:13
EXTERNAL STANDARD	0.101	15:13
BLANK TEST	0.000	15:14

Average = 0.1009
Std Dev = 0.0006.

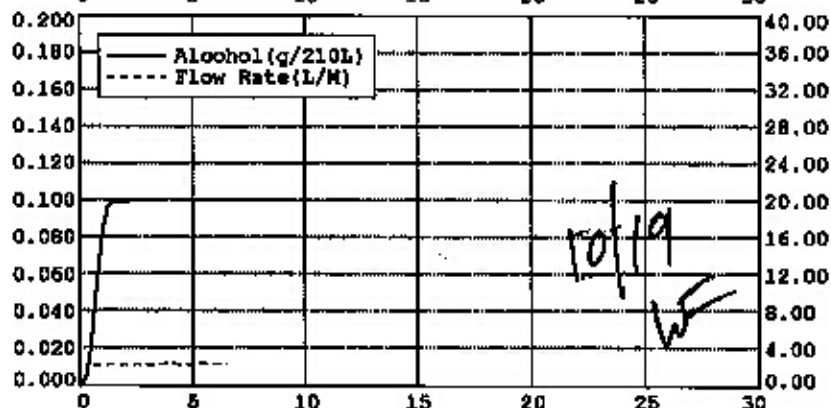
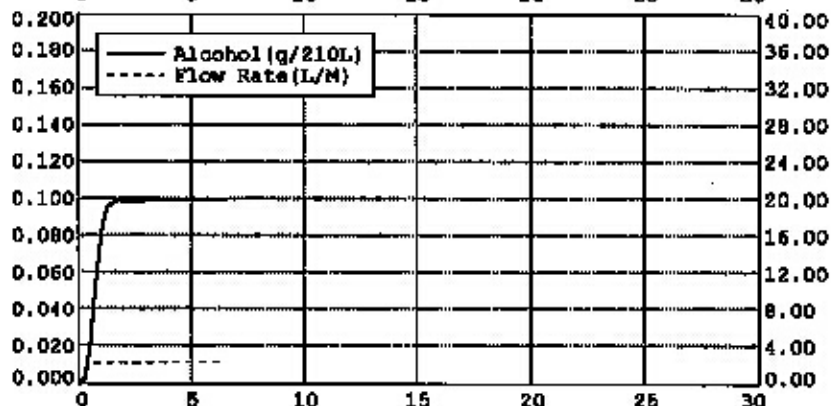
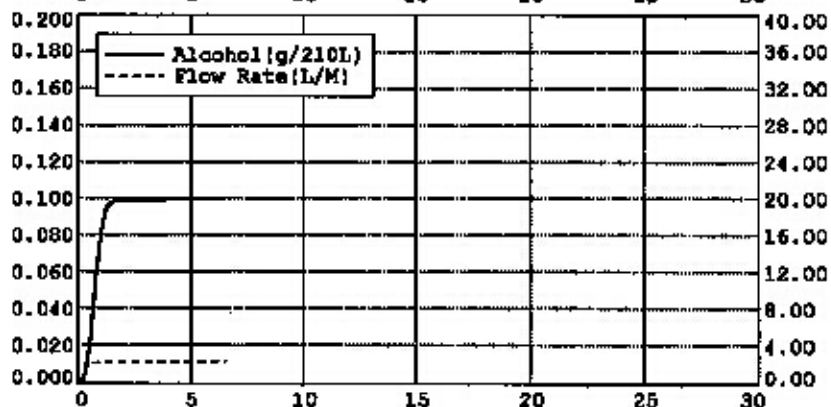
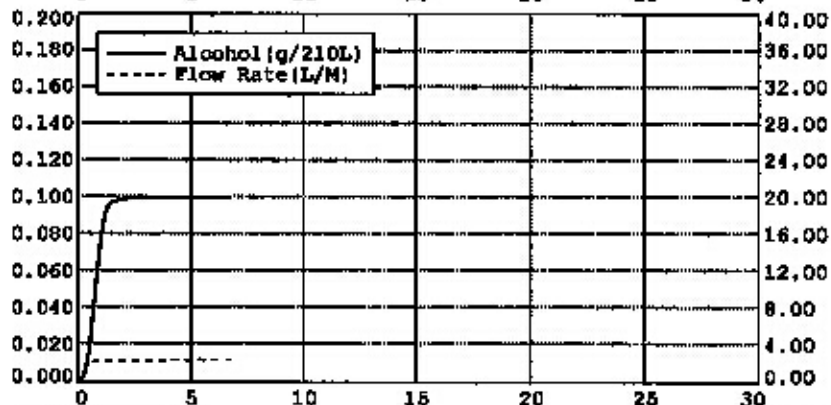
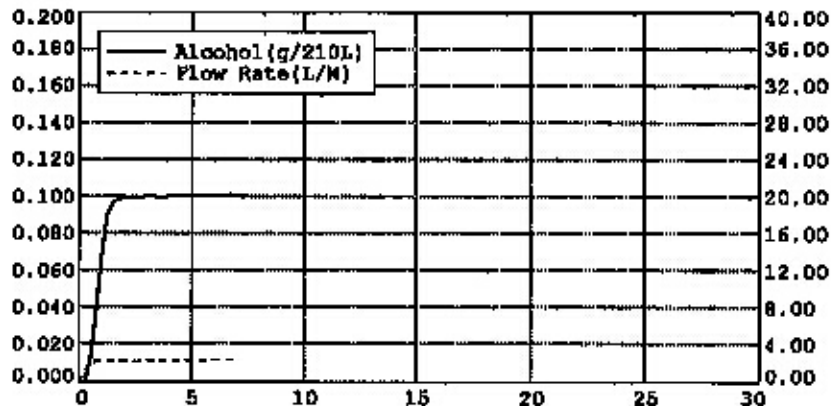

LINEARITY CHECK: Control Test 5

Alaska Department of Public Safety
 DATAMASTER dnt: 100390

Date: 04/27/2012
 Time: 15:20:02

EXTERNAL STANDARD INFORMATION

NOMINAL: 0.200
 LOT #: 11120
 EXPIRATION: 07/19/2013

BLANK TEST	0.000	15:21
INTERNAL STANDARD	VERIFIED	15:21
EXTERNAL STANDARD	0.205	15:22
BLANK TEST	0.000	15:23
EXTERNAL STANDARD	0.204	15:23
BLANK TEST	0.000	15:24
EXTERNAL STANDARD	0.205	15:25
BLANK TEST	0.000	15:26
EXTERNAL STANDARD	0.204	15:26
BLANK TEST	0.000	15:27
EXTERNAL STANDARD	0.204	15:28
BLANK TEST	0.000	15:28

Average = 0.2049
 Std Dev = 0.0003

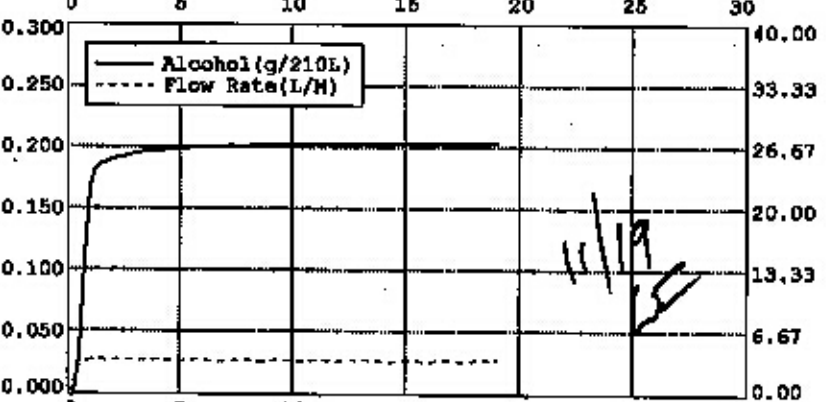
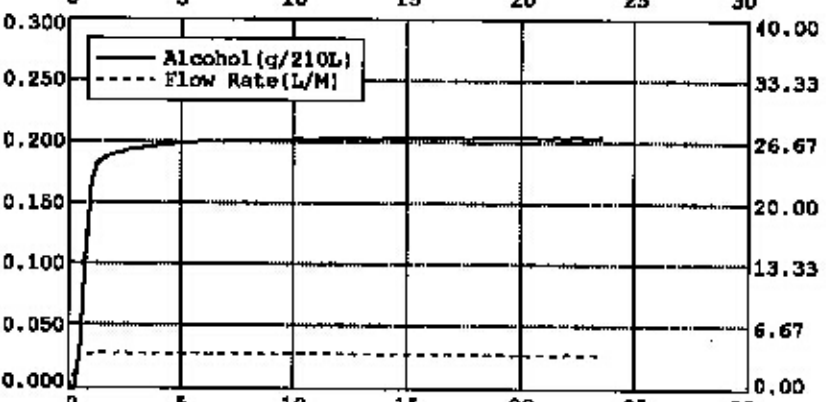
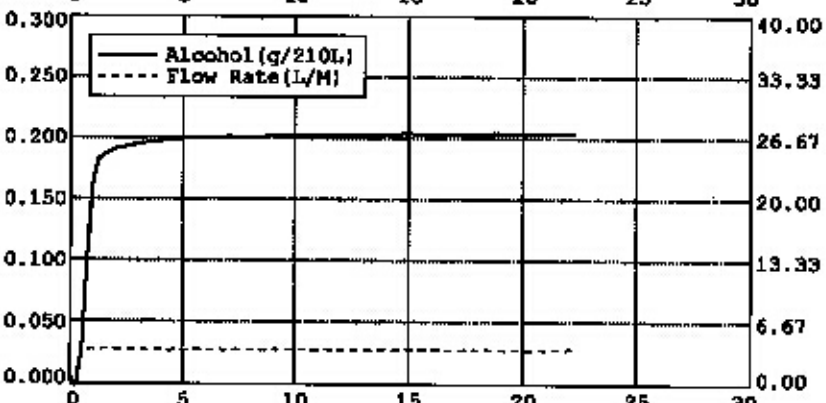
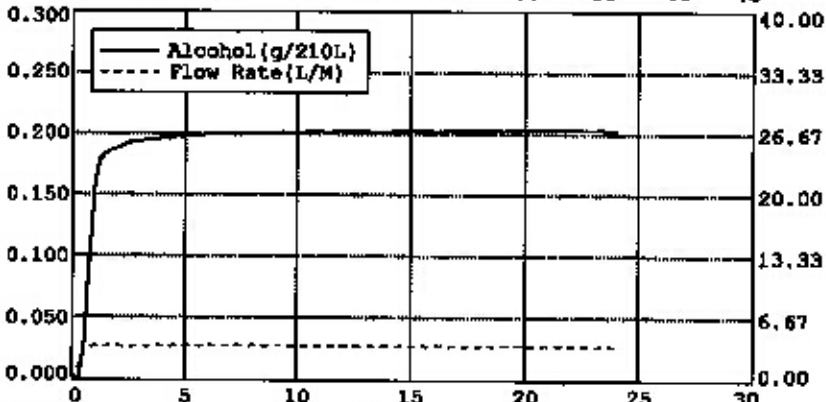
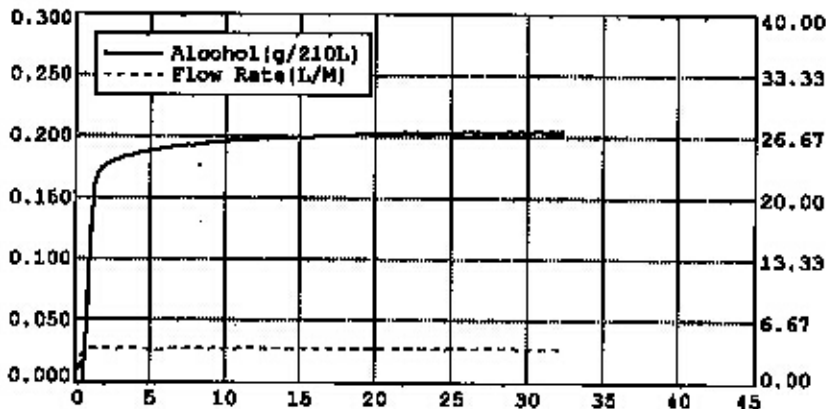

LINEARITY CHECK: Control Test 6

Alaska Department of Public Safety
 DATAMASTER dnt: 100390

Date: 04/27/2012
 Time: 15:31:27

EXTERNAL STANDARD INFORMATION

NOMINAL: 0.300
 LOT #: 11110
 EXPIRATION: 07/13/2013

BLANK TEST	0.000	15:32
INTERNAL STANDARD	VERIFIED	15:32
EXTERNAL STANDARD	0.307	15:33
BLANK TEST	0.000	15:34
EXTERNAL STANDARD	0.305	15:34
BLANK TEST	0.000	15:35
EXTERNAL STANDARD	0.305	15:36
BLANK TEST	0.000	15:37
EXTERNAL STANDARD	0.305	15:37
BLANK TEST	0.000	15:38
EXTERNAL STANDARD	0.305	15:38
BLANK TEST	0.000	15:39

Average = 0.3059
 Std Dev = 0.0007

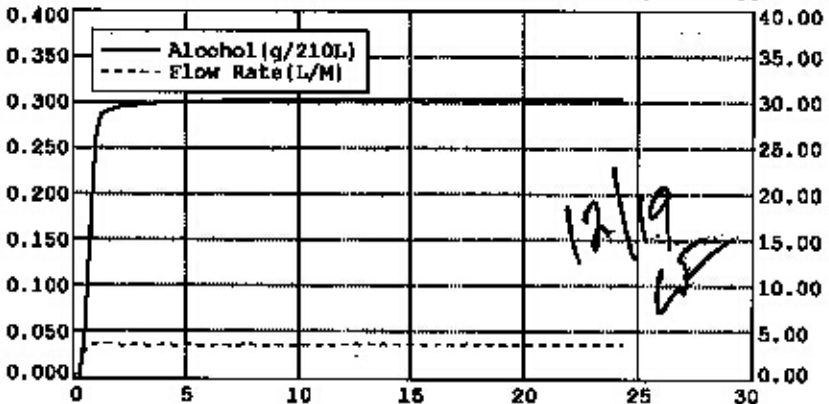
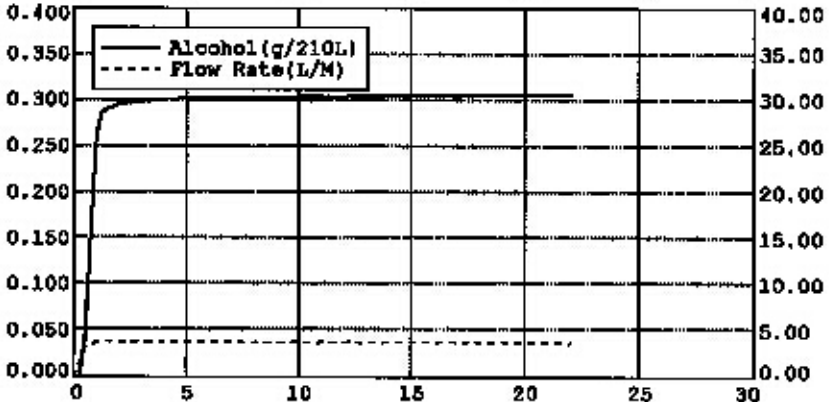
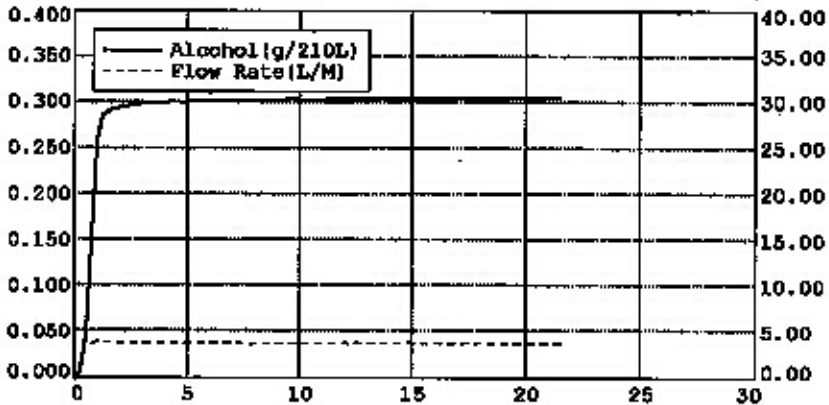
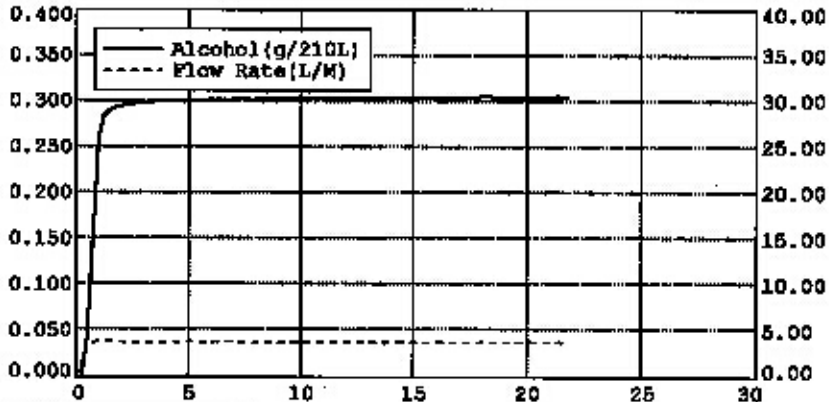
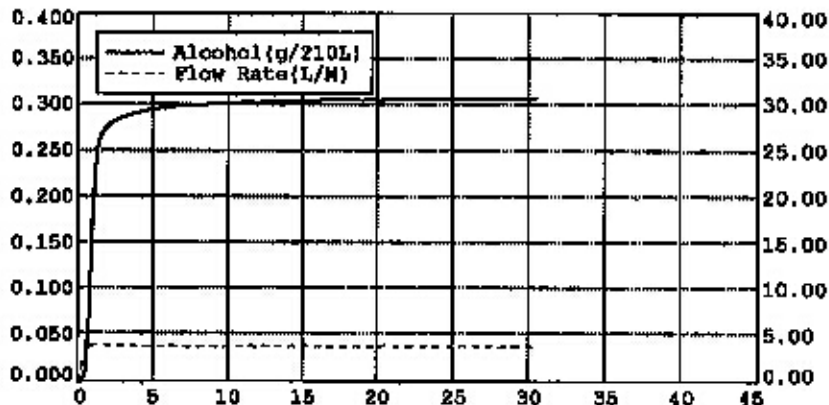

SUBJECT TEST

Alaska Department of Public Safety
LABORATORY div: 100390

Date: 04/30/2012
Time: 08:24:11

SUBJECT NAME:
TEST TEST
LICENSE #: XXXX

OPERATOR NAME:
INCOMPLETE XXXX
OPERATOR'S #: XXXX

DEPT/AGENCY:
XXXX
CASE/REPORT: XXXX
TEST TYPE: TEST

EXTERNAL STANDARD INFORMATION

NOMINAL: 0.080
TARGET AT 29.49: 0.078
LOT #: 07511080A1
EXPIRATION: 03/01/2013

DIAGNOSTIC CHECK	PASSED	08:26
BLANK TEST	0.000	08:26
INTERNAL STANDARD	VERIFIED	08:26
EXTERNAL STANDARD	0.081	08:27
BLANK TEST	0.000	08:27
SUBJECT SAMPLE	INCOMPLETE	08:29

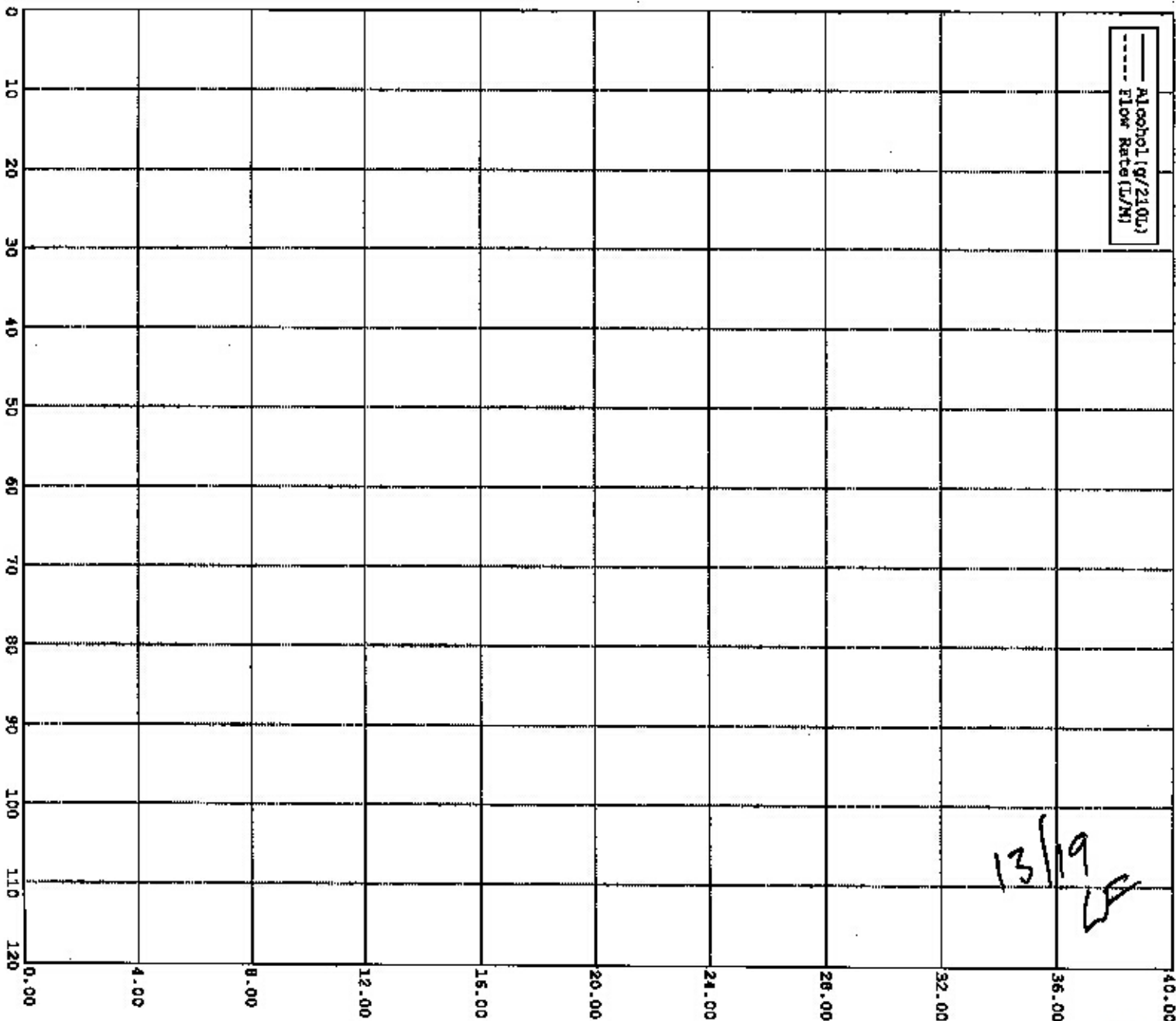

SUBJECT TEST

Alaska Department of Public Safety
DATAMASTER dat: 100390

Date: 04/30/2012
Time: 09:30:54

SUBJECT NAME:
TEST TEST
LICENSE #: XXXX
OPERATOR NAME:
INVALID MOTOR ECCE
OPERATOR'S #: XXXX

DEPT/AGENCY:
XXXX
CASE/REPORT: XXXX
TEST TYPE: TEST

EXTERNAL STANDARD INFORMATION
NOMINAL: 0.090
TARGET AT 29.45: 0.078
LOT #: 07511080A1
EXPIRATION: 03/01/2013

DIAGNOSTIC CHECK	PASSED	09:35
BLANK TEST	0.000	09:35
INTERNAL STANDARD	VERIFIED	09:35
EXTERNAL STANDARD	0.061	09:36
BLANK TEST	0.000	09:37
SUBJECT SAMPLE	INVALID	09:37

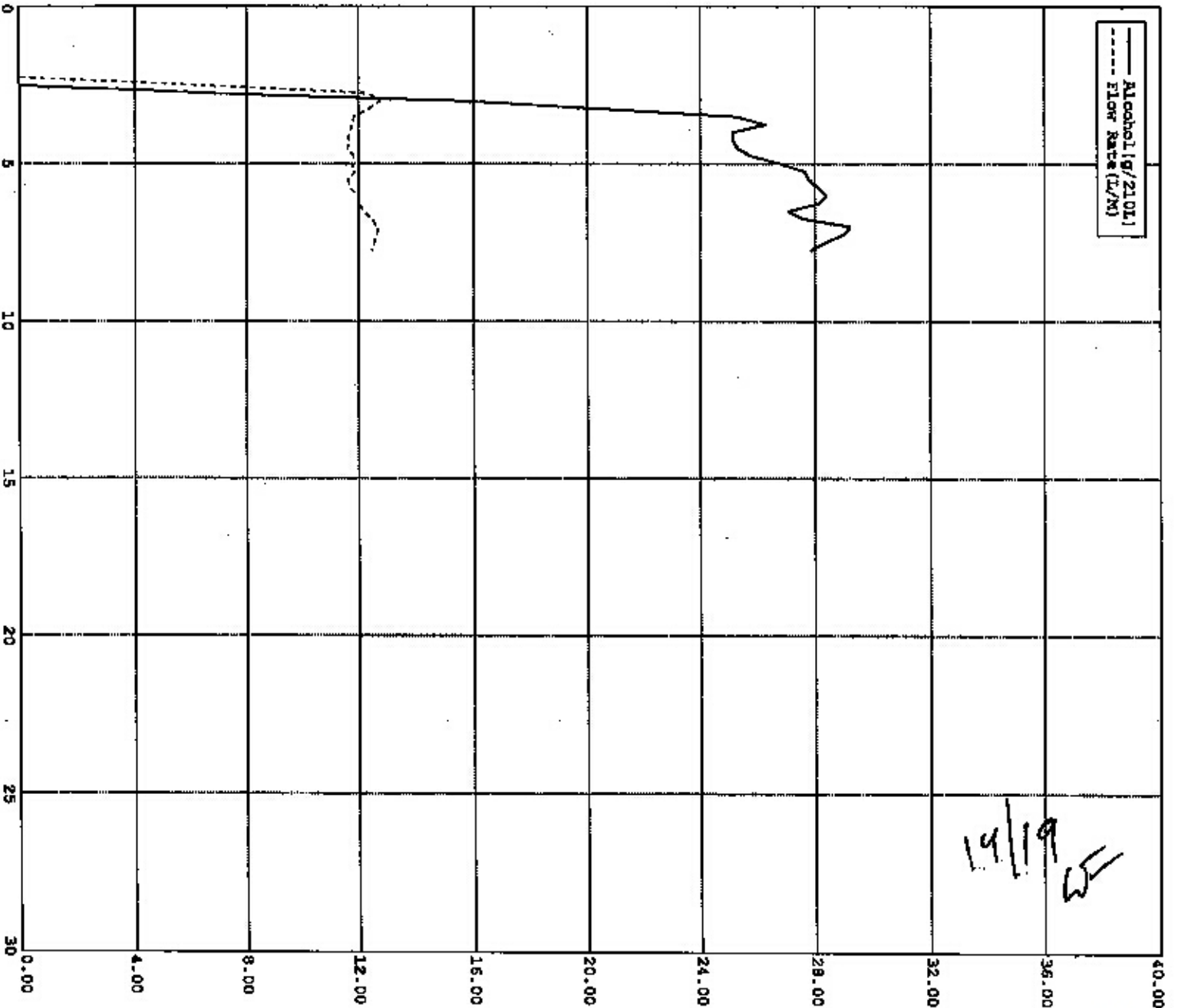

SUBJECT TEST

Alaska Department of Public Safety
LABORATORY dmt: 100390

Date: 04/30/2012
Time: 10:48:57

SUBJECT NAME:
TEST TEST
LICENSE #: XXXX

OPERATOR NAME:
INTERFERENCE FICHE AND ACERONE
OPERATOR'S #: XXXX

DEPT/AGENCY:
XXXX
CASE/REPORT: XXXX
TEST TYPE: TEST

EXTERNAL STANDARD INFORMATION
NOMINAL: 0.080
TARGET AT 29.48: 0.079
LOT #: 02012080A1
EXPIRATION: 03/01/2014

DIAGNOSTIC CHECK	PASSED	10:50
BLANK TEST	0.000	10:50
INTERNAL STANDARD	VERIFIED	10:50
Xc = 0.093 (3.11%)	0.079	10:50
EXTERNAL STANDARD	I [1] = 0.0799 (-0.0002) (0.0036)	
BLANK TEST	0.000	10:51
SUBJECT SAMPLE	INTERFERENCE	10:52
X [1] = 0.0807 (-0.0127) (0.0012)		

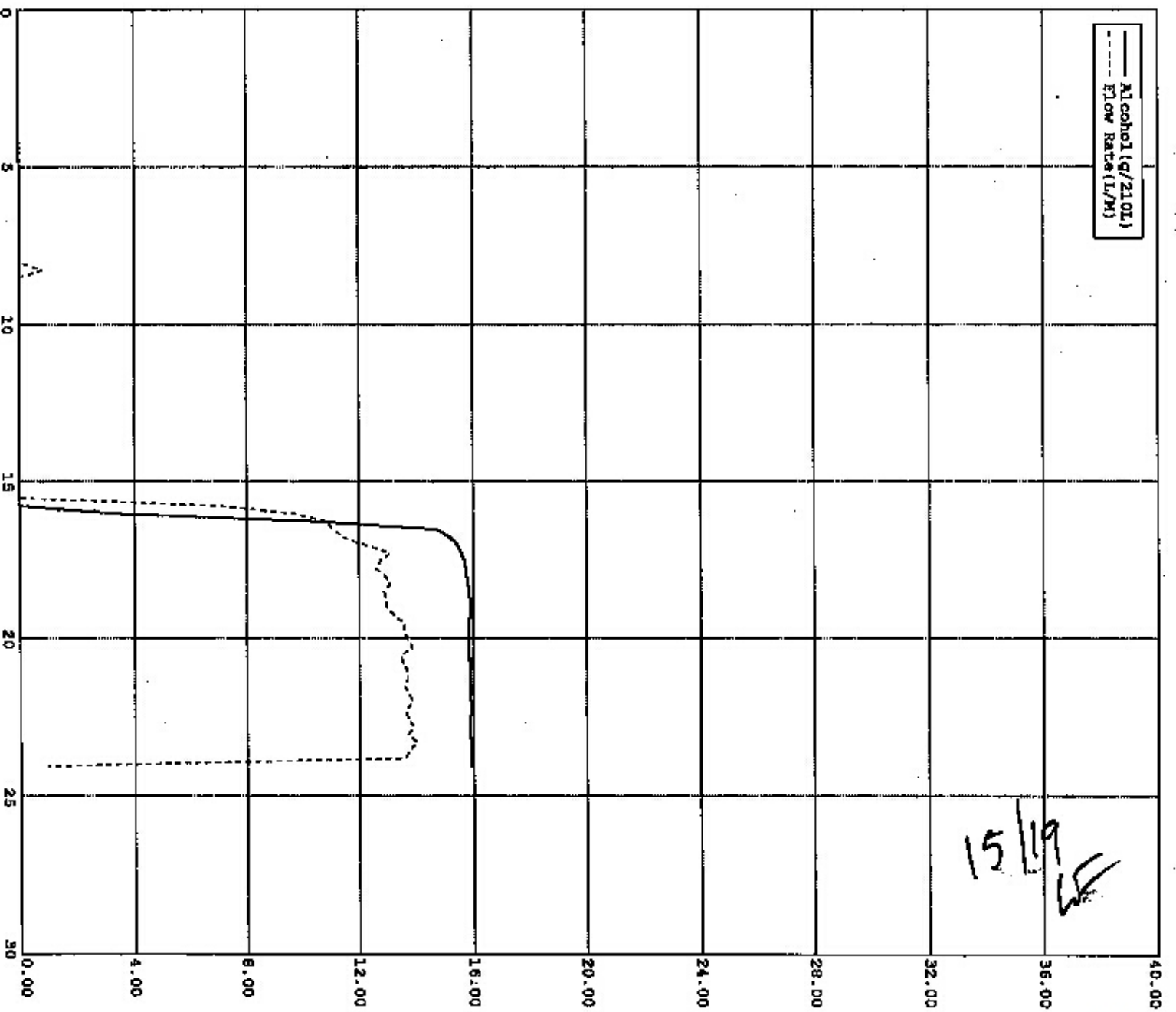

SUBJECT TEST

Alaska Department of Public Safety
 INVENTORY NUMBER date: 100390

Date: 04/30/2012
 Time: 11:08:29

SUBJECT NAME:
 TEST TEST
 LICENSE #: XXXX

OPERATOR NAME:
 INTERFERENCE FROM AND IPA
 OPERATOR'S #: XXXX

DEPT/AGENCY:
 XXXX
 CASE/REPORT: XXXX
 TEST TYPE: TEST

EXTERNAL STANDARD INFORMATION
 NOMINAL: 0.080
 TARGET AT 29.49: 0.078
 LOT #: 02012080A1
 EXPIRATION: 03/01/2014

DIAGNOSTIC CHECK	PASSED	11:10
BLANK TEST	0.000	11:10
INTERNAL STANDARD	VERIFIED	11:10
Xq = 0.094 (1.74%)		
EXTERNAL STANDARD	0.080	11:10
X[1] = 0.0806 (0.0006)	(0.0031)	11:11
BLANK TEST	0.000	11:11
SUBJECT SAMPLE	INTERFERENCE	11:11
X[1] = 0.0922 (-0.0235)	(0.0012)	

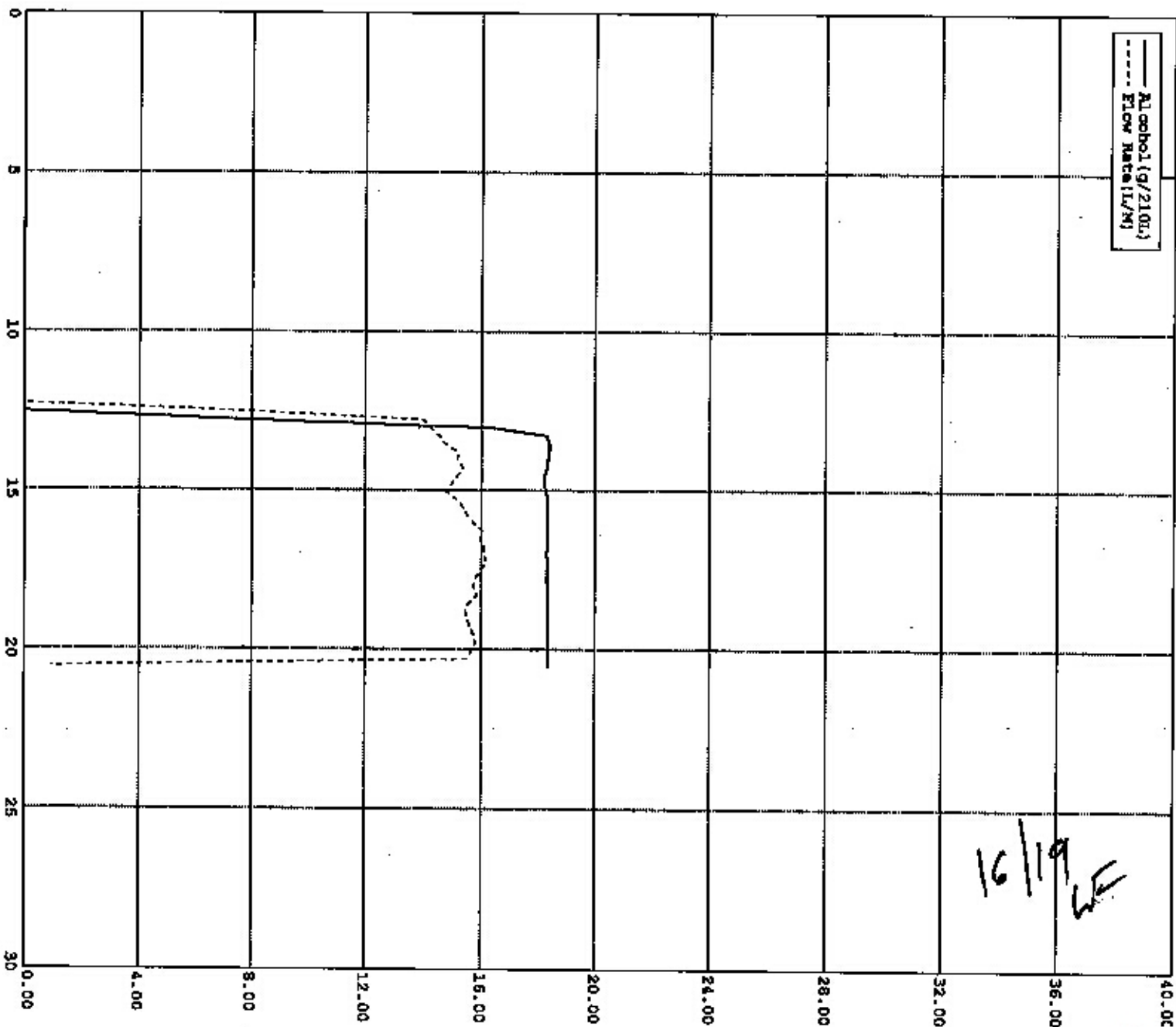

SUBJECT TEST

Alaska Department of Public Safety
 DATABASE# dnt: 100390

Date: 04/30/2012
 Time: 11:23:11

SUBJECT NAME:
 TEST TEST
 LICENSE #: XXXX

OPERATOR NAME:
 INTERFERENCE ECHO ONLY
 OPERATOR'S #: XXXX

DEPT/AGENCY:
 XXXX
 CASE/REPORT: XXXX
 TEST TYPE: TEST

EXTERNAL STANDARD INFORMATION
 NOMINAL: 0.080
 TARGET AT 29.49: 0.076
 LOT #: 02012080A1
 EXPIRATION: 03/01/2014

DIAGNOSTIC CHECK	PASSED	11:26
BLANK TEST	0.000	11:27
INTERNAL STANDARD	VERIFIED	11:27
X _d = 0.093 (2.83%)		
EXTERNAL STANDARD	0.080	11:27
X[1] = 0.0800 (-0.0005)	(0.0023)	
BLANK TEST	0.000	11:28
SUBJECT SAMPLE (Vol=2.02L)	0.096	11:28
X[1] = 0.0967 (-0.0009)	(0.0014)	
BLANK TEST	0.000	11:29
EXTERNAL STANDARD	0.080	11:29
X[1] = 0.0808 (0.0007)	(0.0034)	
BLANK TEST	0.000	11:30

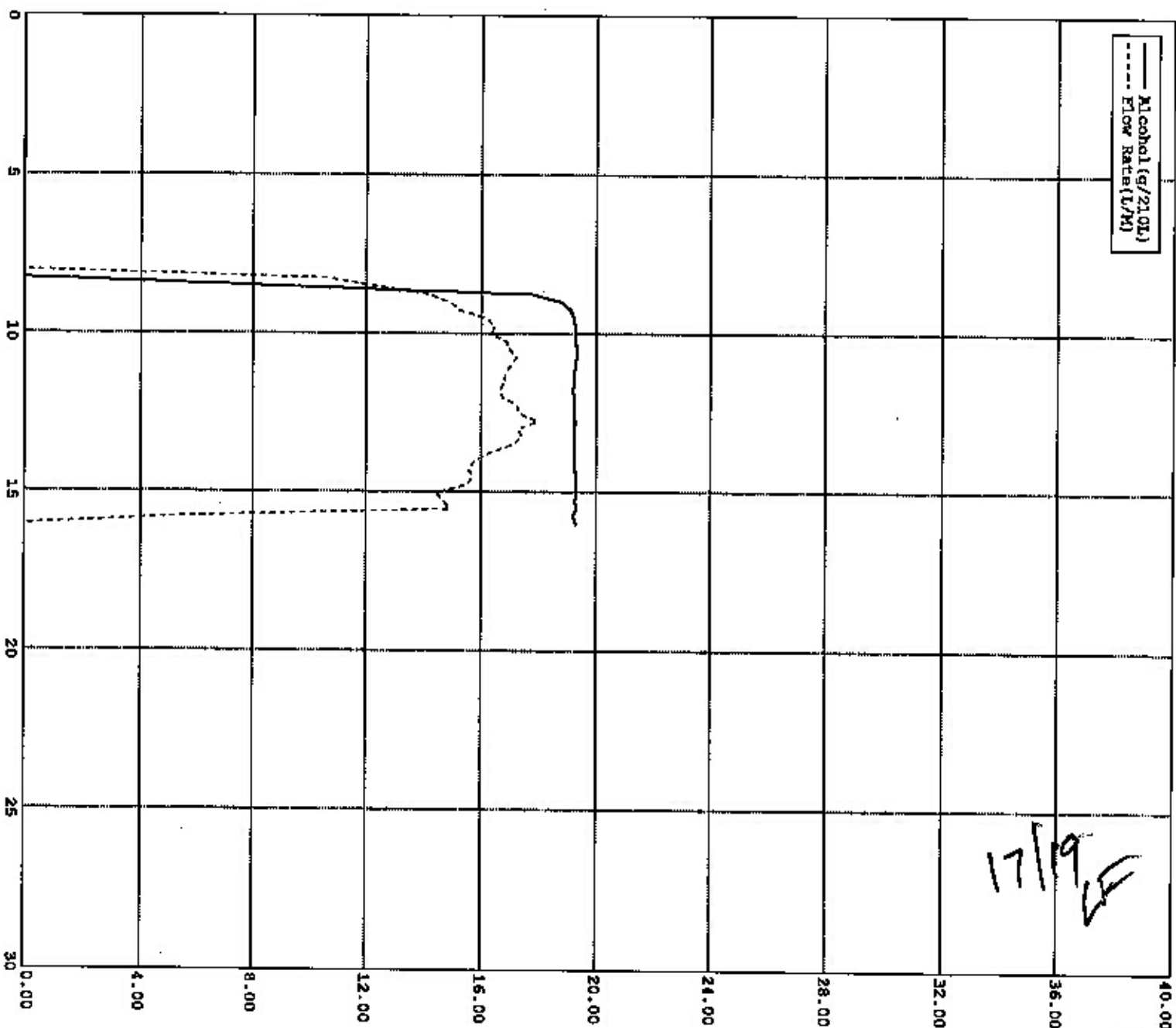

SUBJECT TEST

Alaska Department of Public Safety
 DATA MASTER dnt: 100390

Date: 04/30/2012
 Time: 11:41:55

SUBJECT NAME:
 TEST TEST
 LICENSE #: XXXX

OPERATOR NAME:
 RPT XXXX
 OPERATOR'S #: XXXX

DEPT/AGENCY:
 XXXX
 CASE/REPORT: XXXX
 TEST TYPE: TEST

EXTERNAL STANDARD INFORMATION
 NOMINAL: 0.080
 TARGET AT 29.49: 0.078
 LOT #: 02012080A1
 EXPIRATION: 03/01/2014

DIAGNOSTIC CHECK
 BLANK TEST PASSED 11:43
 INTERNAL STANDARD 0.000 11:43
 INTERNAL STANDARD VERIFIED 11:44
 INTERNAL STANDARD 0.081 11:44
 BLANK TEST 0.000 11:45
 RFI DETECTED

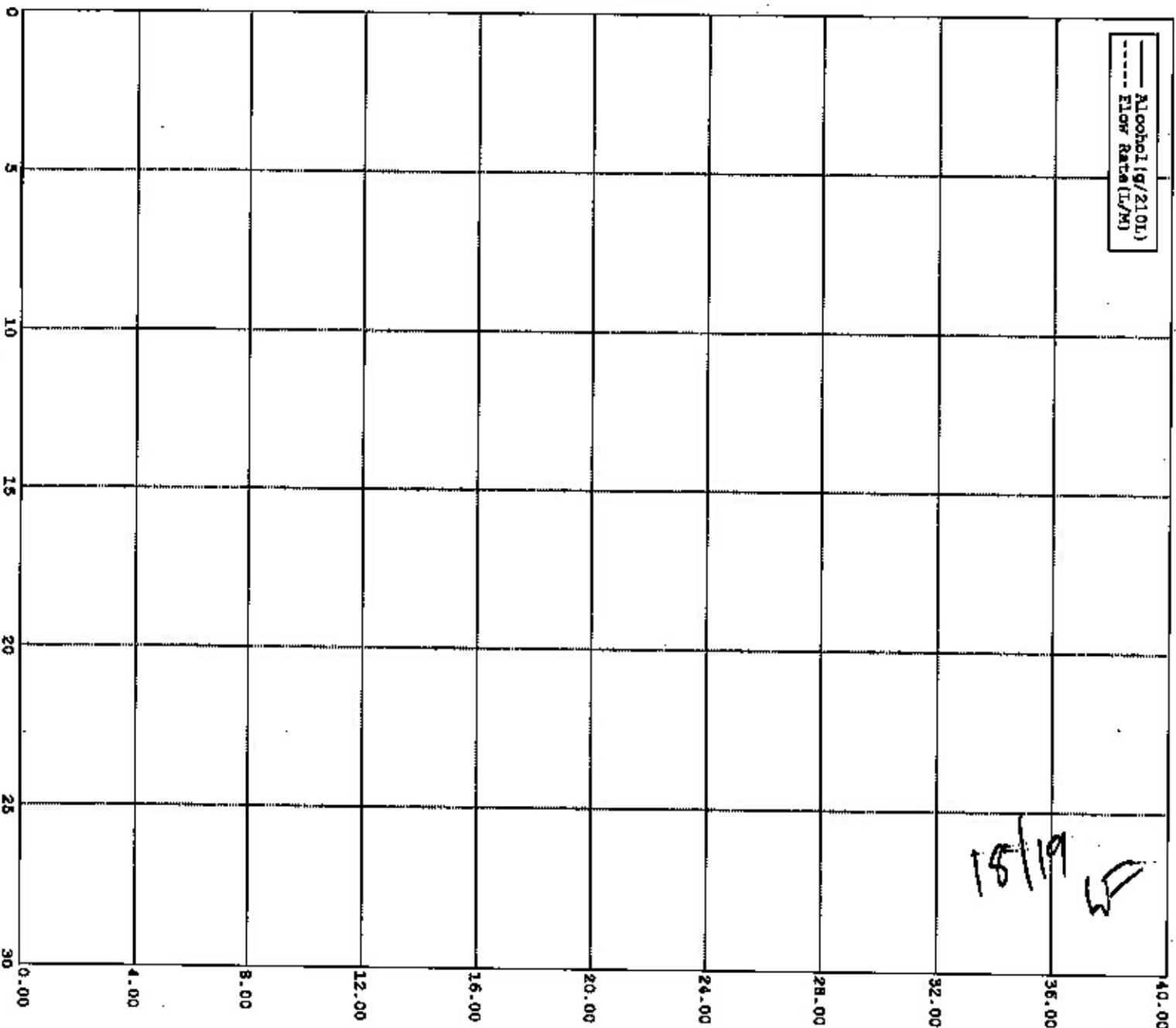

SUBJECT TEST

Alaska Department of Public Safety
DATAMASTER dnt: 100390

Date: 04/30/2012
Time: 13:41:32

SUBJECT NAME:
TEST TEST
LICENSE #: XXXX

OPERATOR NAME:
CHARLES FOSTER
OPERATOR'S #: 7734

DEPT/AGENCY:
XXXX
CASE/REPORT: XXXX
TEST TYPE: TEST

REFERENCE STANDARD INFORMATION
NOMINAL: 0.080
TARGET AT 29.48: 0.078
LOT #: 02012080A1
EXPIRATION: 03/01/2014

DIAGNOSTIC CHECK	PASSED	13:48
BLANK TEST	0.000	13:48
INTERNAL STANDARD	VERIFIED	13:48
EXTERNAL STANDARD	0.080	13:48
BLANK TEST	0.000	13:49
SUBJECT SAMPLE	0.000	13:50
BLANK TEST	0.000	13:50
EXTERNAL STANDARD	0.081	13:51
BLANK TEST	0.000	13:52

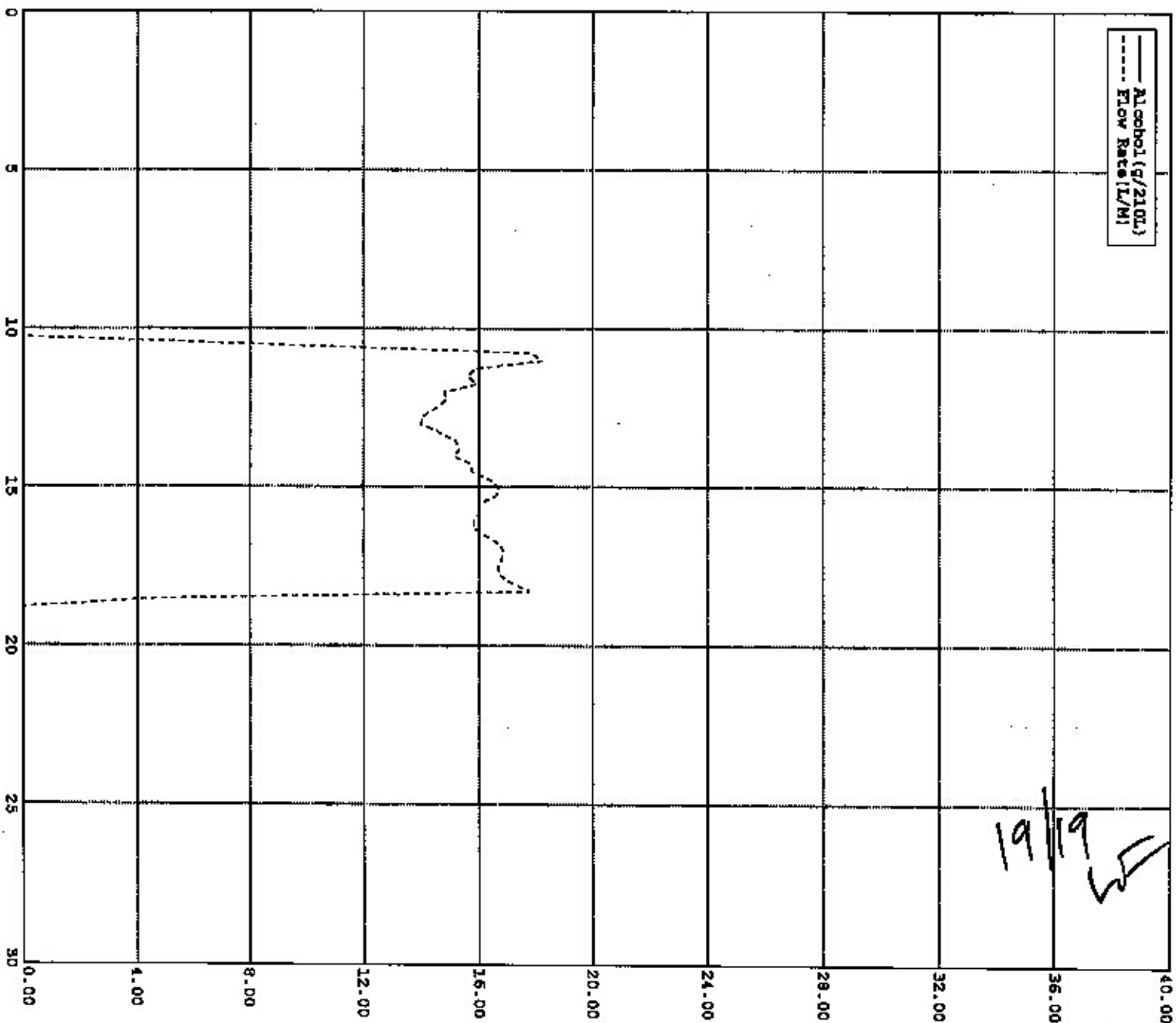

Final page for report

\

\\ANCSCLSAN01\JTRAX\CASEDOCS\B-100390\B-100390_ECF-20140

2/19/2014