

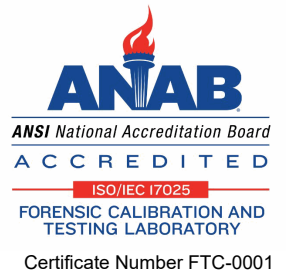

State of Alaska
 Department of Public Safety
Scientific Crime Detection Laboratory

4805 Dr. Martin Luther King Jr. Ave.
 Anchorage, Alaska 99507
 David Kanaris, Chief, Forensic Laboratories



Breath Alcohol Calibration Report
Calibration Item: DataMaster DMT
Serial Number: 100696

Report Issue Date: 08/27/2024
Date Received: 2024-05-06
Condition of Item: No apparent damage

Method Used: DataMaster DMT Calibration / Current Breath Alcohol Procedure Manual
Calibration Range: 0.020 g/210L - 0.300 g/210L

As-Found Data								
Nominal Values (g/210L)	Target Values (g/210L)	Lot Number	Results (g/210L)					Mean (g/210L)
0.020	0.020	AG217902	0.021	0.020	0.020	0.020	0.020	0.020
0.080	0.079	AG335202	0.080	0.080	0.080	0.080	0.079	0.080
0.300	0.295	AG327804	0.297	0.297	0.297	0.297	0.297	0.297

As Found - Evaluation Analyst: Colleen O'Bryant
 As Found Conditions - Barometric Pressure (inHg): 29.29 Barometer Used: Fisher S/N 230307229 Temperature (C): 21.5 Relative Humidity (%): 29
 As-Found Lab Activity Date Range: 05/07/2024 - 05/07/2024

As-Left Data									
Nominal Values (g/210L)	Target Values (g/210L)	Lot Number	Results (g/210L)					Mean (g/210L)	Uncertainty (g/210L)
0.020	0.020	AG408002	0.020	0.020	0.020	0.019	0.019	0.020	+/- 0.002
0.040	0.039	AG407908	0.039	0.039	0.039	0.039	0.039	0.039	+/- 0.003
0.080	0.079	AG335202	0.077	0.077	0.077	0.077	0.077	0.077	+/- 0.004
0.100	0.098	AG333401	0.097	0.097	0.097	0.097	0.097	0.097	+/- 0.004
0.150	0.147	AG332004	0.142	0.142	0.142	0.142	0.142	0.142	+/- 0.006
0.300	0.295	AG327804	0.289	0.288	0.288	0.288	0.288	0.288	+/- 0.012

As Left Conditions - Barometric Pressure (inHg): 29.43 Barometer Used: Fisher S/N 230307229 Temperature (C): 20.8 Relative Humidity (%): 45
 As-Left Lab Activity Date Range: 07/29/2024 - 07/29/2024

Calibration is performed using dry gas standards traceable to NIST. Standards are sourced from an external provider accredited to ISO/IEC 17025 and ISO 17034 standards. Internal instrument barometer readings are traceable to NIST. External barometers are calibrated by an external calibration provider accredited to the ISO/IEC 17025 standard.

The As-Left results listed above include the estimated measurement uncertainty with a coverage factor k=2 and an expanded coverage probability of 95%. The estimated uncertainty applies to the calibration process and not to subject breath samples.

This report applies only to the item being calibrated and shall not be reproduced, except in full, without written approval from the laboratory.

Megan Carlock

Results authorized by Megan Carlock on 07/29/2024

megan.crouse@alaska.gov

Technically and administratively reviewed by Colleen O'Bryant on 08/27/2024

Alaska Scientific Crime Detection Laboratory

DataMaster Calibration Form

Effective: 1/23/2024

Version: 4.0

Instrument #: 100696 Analyst or Technician Name: Megan Carlock
DataMaster DMT Calibration Start Date: 7/29/24

Diagnostic Test

- Perform Diagnostic Test (View Details)
- Internal Standard Value \leq 3.00%

Technician Screen and Calibration Factors

- Adjust Voltages (if needed)
 - Lamp (2.60 V Maximum)
 - Bias
 - Cooler (2.00 V Maximum)
 - Chopper Frequency
 - Detector Voltage (-0.100V to 0.100V)
- Set RFI Sensitivity
- Adjust internal barometer reading to match NIST-traceable barometer
Barometer/Thermometer/Hygrometer S/N: 230307229
Calibration Due Date: 5/2/2025
- Verify Volume Setting (1.50 L +/- 0.10 L), adjust if needed
- Print Technician Screen
- Print "Cal Factors"

Minimum Volume Test

- Perform Minimum Volume (Subject) Test: 1.5 liters (1.3 L to 1.7 L)

As Left Linearity Testing

Barometric Pressure (in Hg) 29.43 Temperature(C) 20.8 Relative Humidity(%) 45
Approved Concentrations (g/210L): 0.020, 0.040, 0.080, 0.100, 0.150, 0.300

Functional Tests

- Incomplete
- Invalid
- Interference (Volatiles) - *Print with View Details*
- Maximum Attempts Exceeded
- Radio Frequency Interference (RFI)

- Acetone Reagent Lot Number: 20240501KS Expiration Date: 8/1/24
Simulator S/N: SD1088 Thermometer Verification Performed?
- Isopropanol Reagent Lot Number: 20240501MNC Expiration Date: 8/1/24
Simulator S/N: DR4161 Thermometer Verification Performed?
- Negative (Ethanol Only) Lot Number: 22HP41201 Expiration Date: 8/1/24
Simulator S/N: SD1177 Thermometer Verification Performed?

Calibrated External Thermometer S/N: 230631106
Calibration Due Date: 9/19/2025

Administrative

- Verify Stylus Calibration
- Reset Options
- Clear Memory
- Verification of Calibration (VOC)
- Perform Non-Drinking Subject Test
- Upload Instrument
- Remove Dry Gas Tank Before Shutdown
- Add Ready for Tech Review Note

Completion

Lab Work End Date: 7/29/24
Data Interpretation Date (Technician): N/A (if applicable)
Data Interpretation Date (Analyst): 7/29/24

All printed copies are uncontrolled.

Approved by: Chemistry Supervisor

DIAGNOSTIC RECORD

Alaska Department of Public Safety
DATAMASTER dmt: 100696

Date: 07/29/2024
Time: 09:24:34

VERSIONS
DMT: 3.02
PIC: 3.03
Modem: 2.6
Questions: 2.2

TEMPERATURES

Sample Chamber = 48.9°C PASSED
(44.0°C - 52.0°C)
Breath Tube = 44.3°C PASSED
(38.0°C - 50.0°C)

SETTINGS

Lamp Voltage = 1.69 V PASSED
(1.01 V - 2.37 V)
Cooler Voltage = 1.69 V PASSED
(1.01 V - 2.37 V)
Bias Voltage = 79 V PASSED
(47 V - 111 V)
Chopper Freq = 535 Hz PASSED
(475 Hz - 575 Hz)
Barometer = 29.3 in

PUMP INFO

Flow Rate = 4.575 L/M PASSED
(3.500 L/M - 6.500 L/M)

DETECTOR INFO

PUMP ON PASSED
(0.002 V <= 0.010 V)
PUMP OFF PASSED
(0.002 V <= 0.010 V)

FILTER INFO

Filter 1 PASSED
Filter 2 PASSED
Filter 3 PASSED

INTERNAL STANDARD

Xq = 0.106 0.00% (0.00% - 4.00%) PASSED

Technician Screen

DATAMASTER dmt: 100696

Date: 07/29/2024
Time: 9:36 AM

Temperatures (°C)
Sample Cell: 48.7°C
Breath Tube: 44.0°C

Current Barometer 29.4 in
Volume (Ltr) 1.54

Settings
Lamp: 1.80 V
Bias: 79 V
Cooler: 1.64 V
Chopper: 533 Hz

Voltages (V)
Flow: 1.04 V
Detector: -0.037 V

CALIBRATION FACTORS

Alaska Department of Public Safety
DATAMASTER dmt: 100696

Date: 06/18/2024
Time: 10:44:23

OPERATOR NAME:
MEGAN CARLOCK
CERTIFICATE #: 10747

Ca = 0.1000
CAL = 0.978091 0.800 <= CAL < 1.200
b1 = 0.0008 0.0000 <= b1 < 0.0040
b2 = 0.0050 0.0010 <= b2 < 0.0100
b3 = 0.0008 0.0000 <= b3 < 0.0040
Xq = 0.1062 0.0500 <= Xq < 0.2000
a21 = 1.179483 1.050 <= a21 < 1.300
a31 = 0.478870 0.300 <= a31 < 0.800

SUBJECT TEST

Alaska Department of Public Safety
DATAMASTER dmt: 100696

Date: 07/29/2024
Time: 09:40:30

SUBJECT NAME:
TEST TEST
LICENSE #: XXX

OPERATOR NAME:
MEGAN CARLOCK
OPERATOR'S #: 10747

DEPT/AGENCY:
MINIMUM VOLUME TEST
CASE/REPORT: XXX
TEST TYPE: TEST

EXTERNAL STANDARD INFORMATION
NOMINAL: 0.080
TARGET AT 29.42: 0.079
LOT #: AG335202
EXPIRATION: 12/18/2025

DIAGNOSTIC CHECK	PASSED	09:42
BLANK TEST	0.000	09:42
INTERNAL STANDARD	VERIFIED	09:42
EXTERNAL STANDARD	0.077	09:42
BLANK TEST	0.000	09:43
SUBJECT SAMPLE (Vol=1.52L)	0.000	09:44
BLANK TEST	0.000	09:45
EXTERNAL STANDARD	0.077	09:45
BLANK TEST	0.000	09:46

MNC

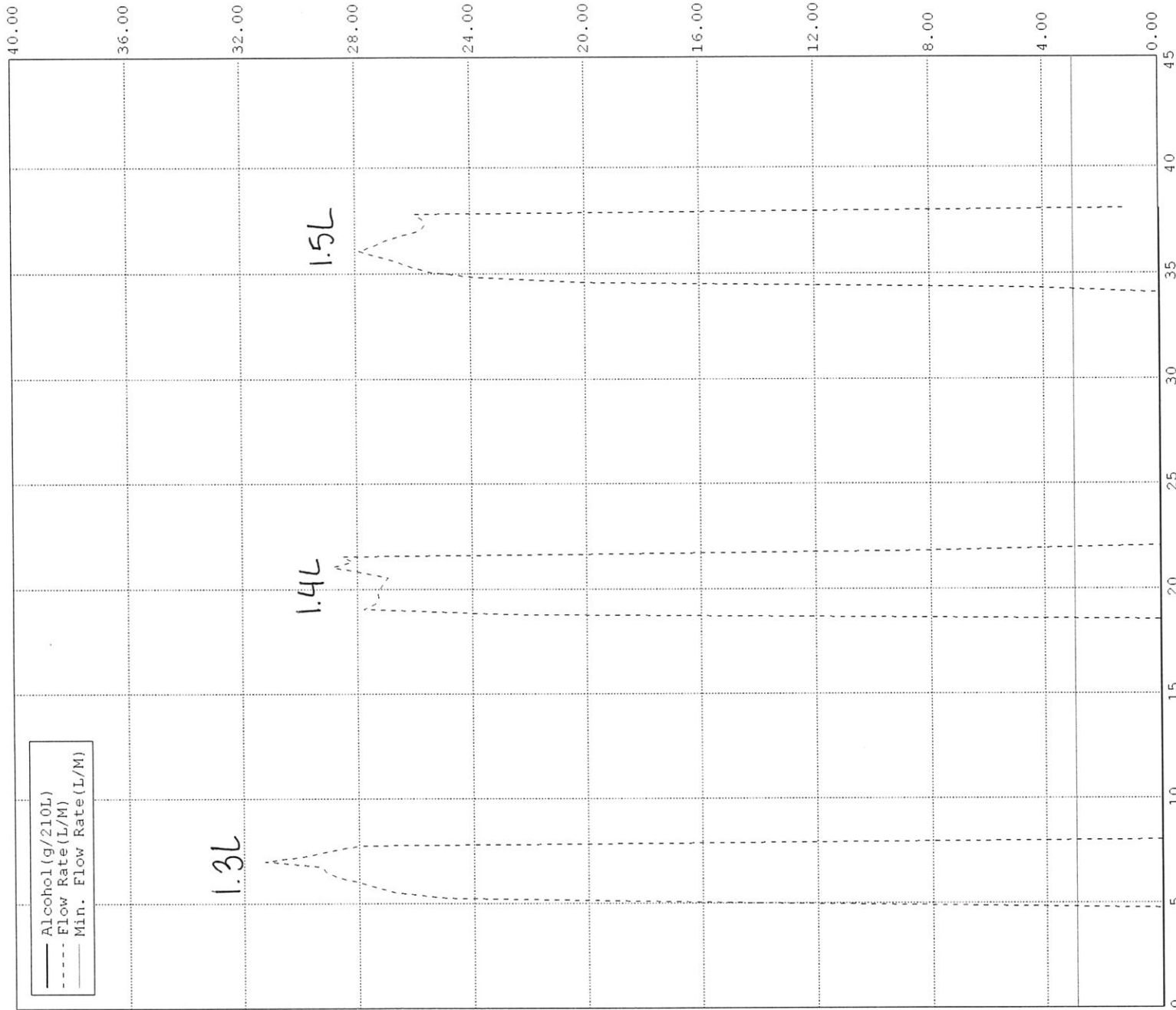

LINEARITY CHECK

 Alaska Department of Public Safety
 DATAMASTER dmt: 100696

Date: 07/29/2024
 Time: 09:50:18

SUPERVISOR NAME:
 MEGAN CARLOCK
 OPERATOR'S #: 10747

TARGET	AVERAGE	STD. DEV.
0.020	0.0196	0.0005
0.039	0.0390	0.0000
0.079	0.0770	0.0000
0.098	0.0970	0.0000
0.147	0.1420	0.0000
0.295	0.2882	0.0004

SLOPE = 0.974141
 R² = 0.999903

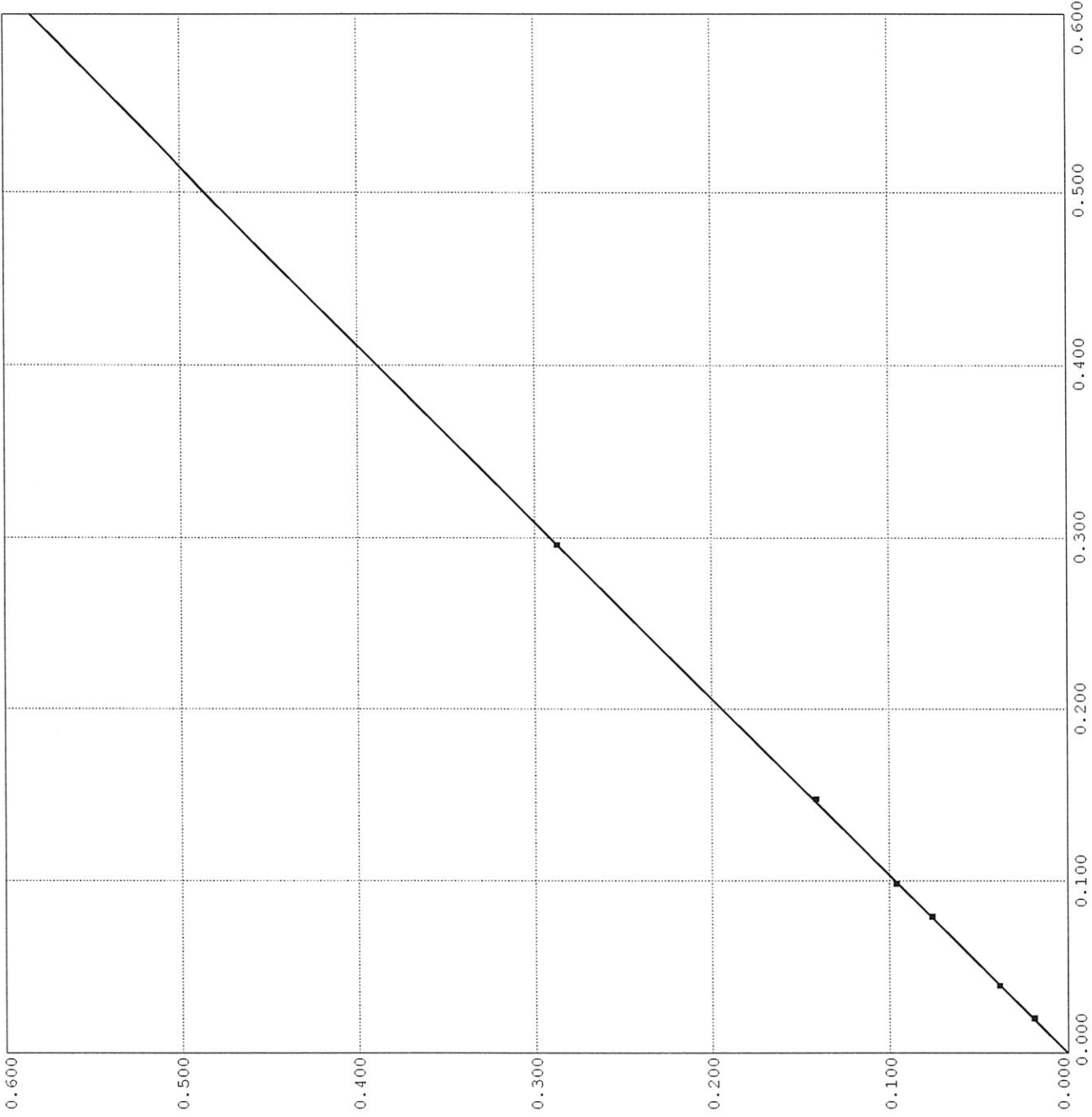

MWC

LINEARITY CHECK: Control Test 1

Alaska Department of Public Safety
DATAMASTER dmt: 100696

Date: 07/29/2024
Time: 09:50:20

EXTERNAL STANDARD INFORMATION

NOMINAL: 0.020
TARGET AT 29.43: 0.020
LOT #: AG408002
EXPIRATION: 03/20/2026
TANK PRESSURE: 540 psi

BLANK TEST	0.000	09:51
INTERNAL STANDARD	VERIFIED	09:51
EXTERNAL STANDARD	0.020	09:52
BLANK TEST	0.000	09:52
EXTERNAL STANDARD	0.020	09:53
BLANK TEST	0.000	09:54
EXTERNAL STANDARD	0.020	09:54
BLANK TEST	0.000	09:55
EXTERNAL STANDARD	0.019	09:55
BLANK TEST	0.000	09:56
EXTERNAL STANDARD	0.019	09:56
BLANK TEST	0.000	09:57

Average = 0.0196
Std Dev = 0.0005

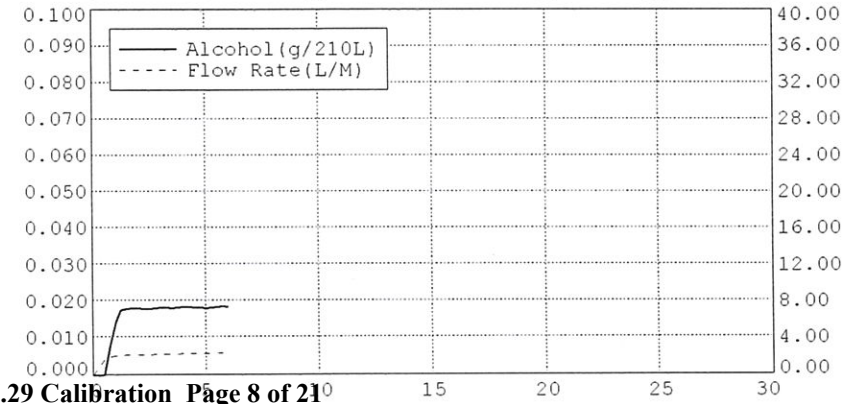
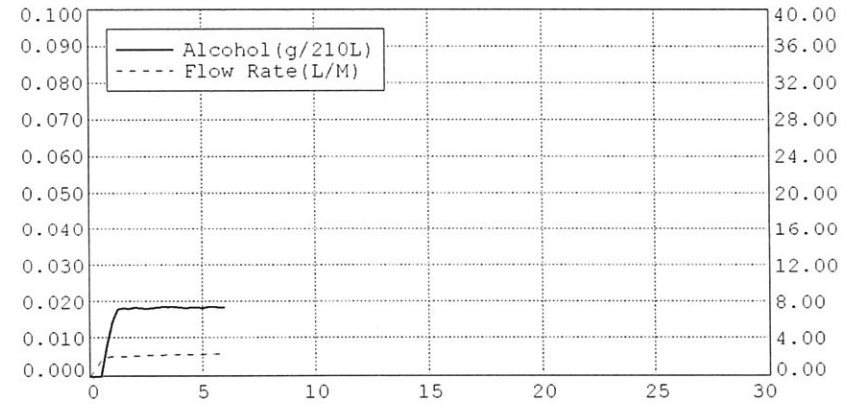
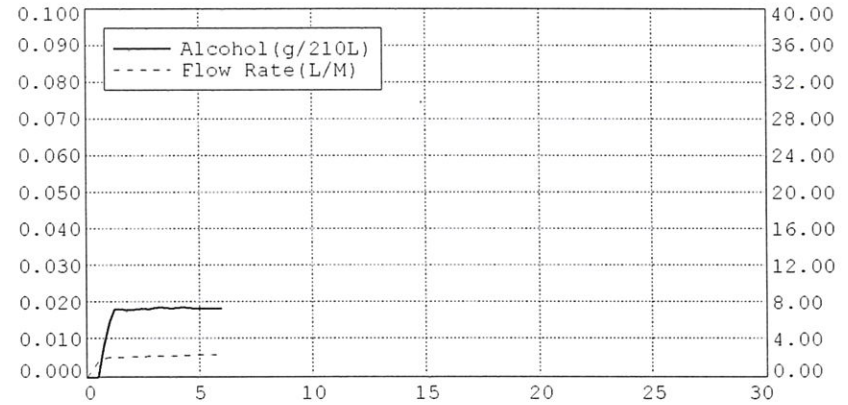
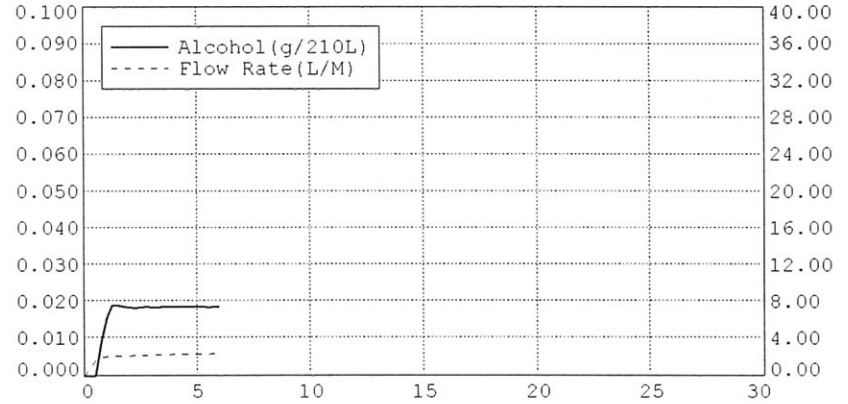
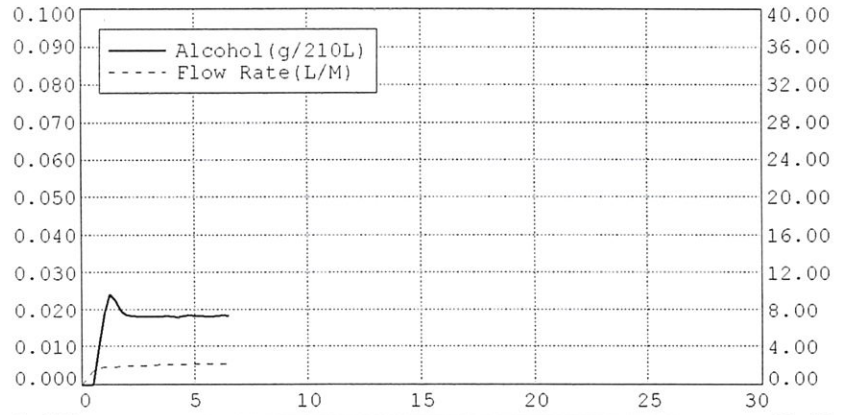

LINEARITY CHECK: Control Test 2

Alaska Department of Public Safety
 DATAMASTER dmt: 100696

Date: 07/29/2024
 Time: 09:58:35

EXTERNAL STANDARD INFORMATION

NOMINAL: 0.040
 TARGET AT 29.42: 0.039
 LOT #: AG407908
 EXPIRATION: 03/19/2026
 TANK PRESSURE: 1079 psi

BLANK TEST	0.000	09:59
INTERNAL STANDARD	VERIFIED	10:00
EXTERNAL STANDARD	0.039	10:00
BLANK TEST	0.000	10:01
EXTERNAL STANDARD	0.039	10:01
BLANK TEST	0.000	10:02
EXTERNAL STANDARD	0.039	10:02
BLANK TEST	0.000	10:03
EXTERNAL STANDARD	0.039	10:03
BLANK TEST	0.000	10:04
EXTERNAL STANDARD	0.039	10:04
BLANK TEST	0.000	10:05

Average = 0.0390
 Std Dev = 0.0000

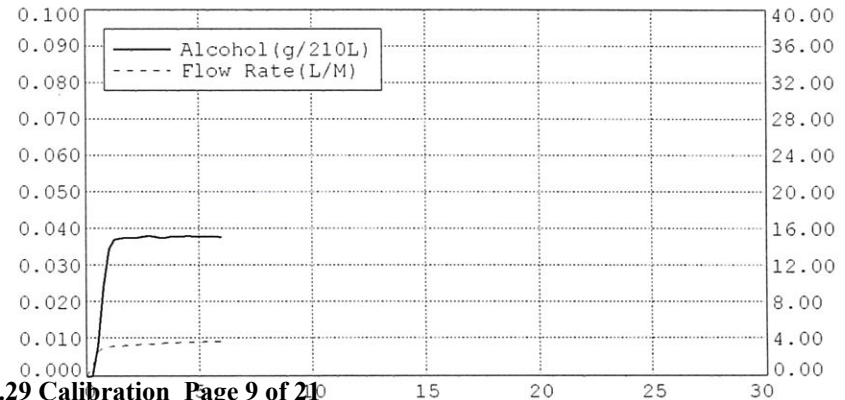
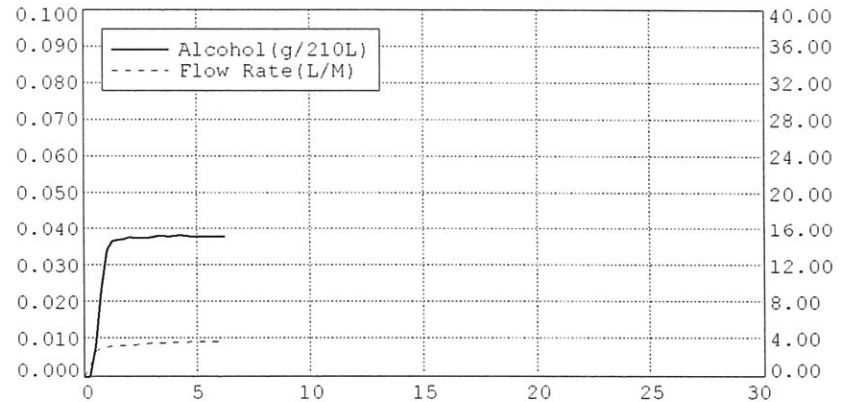
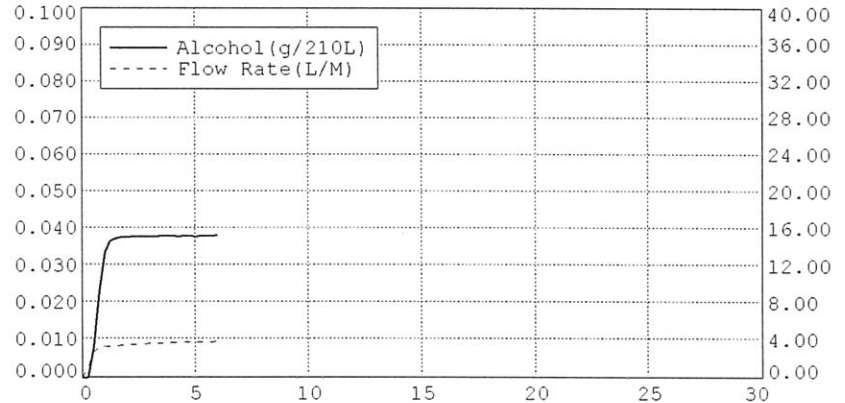
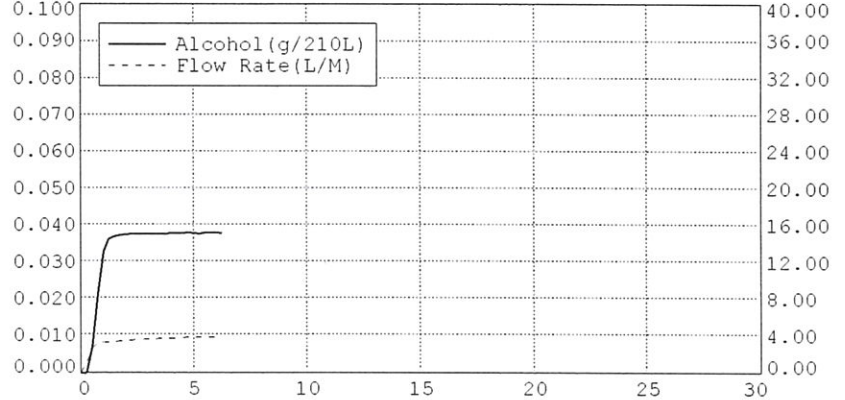
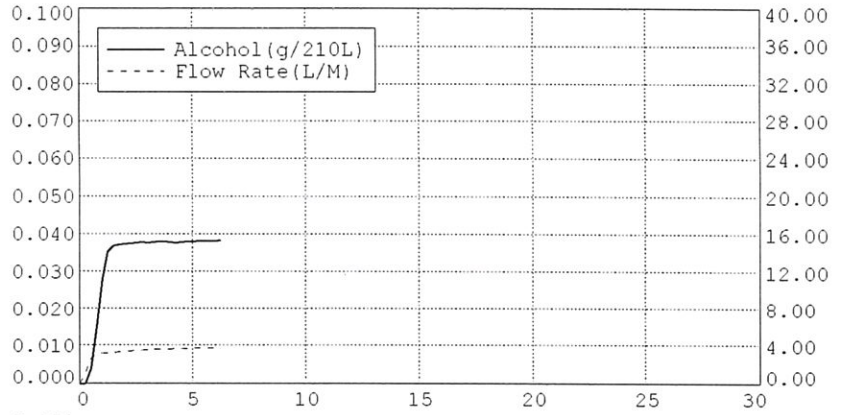

LINEARITY CHECK: Control Test 3

Alaska Department of Public Safety
 DATAMASTER dmt: 100696

Date: 07/29/2024
 Time: 10:08:15

EXTERNAL STANDARD INFORMATION

NOMINAL: 0.080
 TARGET AT 29.42: 0.079
 LOT #: AG335202
 EXPIRATION: 12/18/2025
 TANK PRESSURE: 914 psi

BLANK TEST	0.000	10:09
INTERNAL STANDARD	VERIFIED	10:09
EXTERNAL STANDARD	0.077	10:09
BLANK TEST	0.000	10:10
EXTERNAL STANDARD	0.077	10:10
BLANK TEST	0.000	10:11
EXTERNAL STANDARD	0.077	10:12
BLANK TEST	0.000	10:12
EXTERNAL STANDARD	0.077	10:13
BLANK TEST	0.000	10:14
EXTERNAL STANDARD	0.077	10:14
BLANK TEST	0.000	10:15

Average = 0.0770
 Std Dev = 0.0000

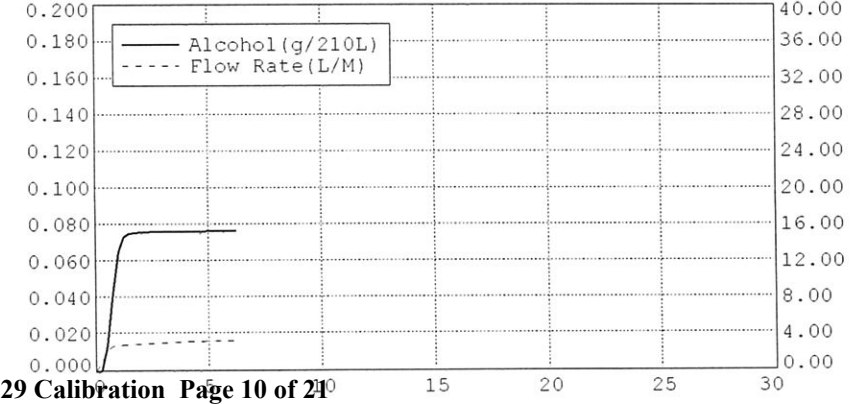
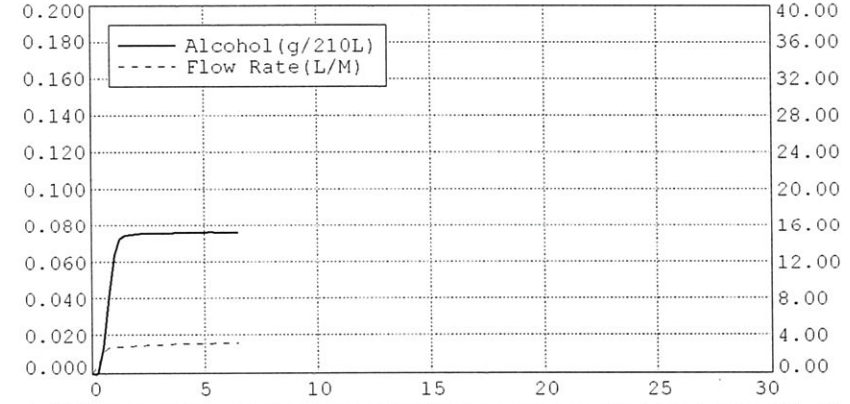
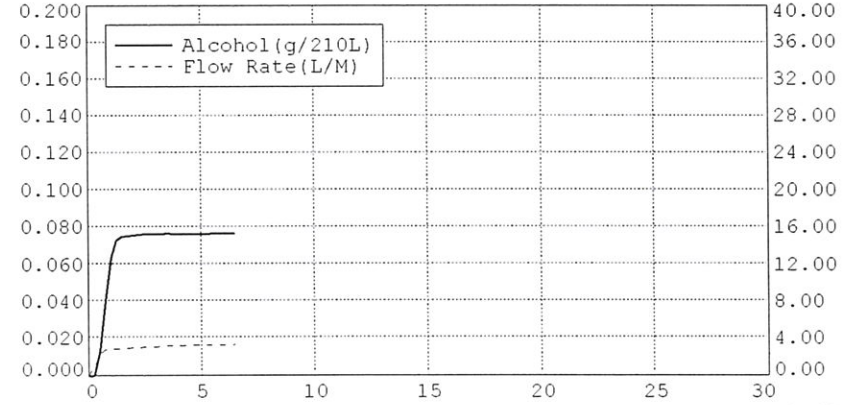
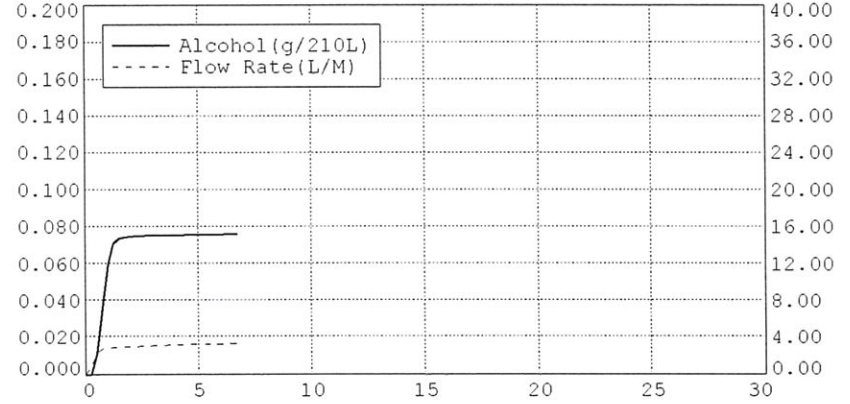
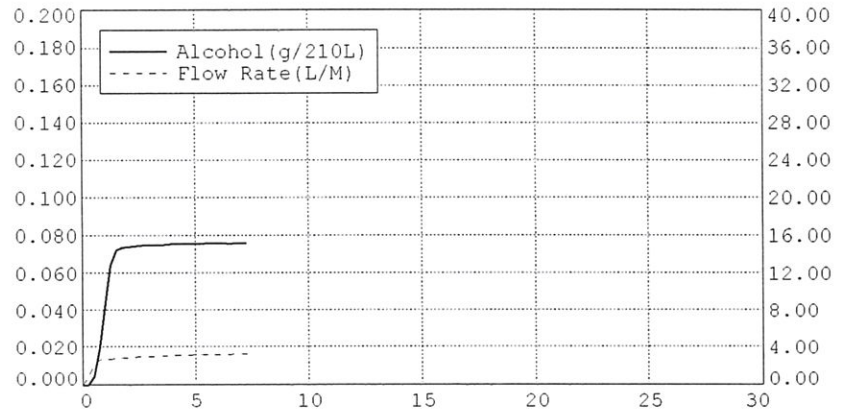

LINEARITY CHECK: Control Test 4

Alaska Department of Public Safety
 DATAMASTER dmt: 100696

Date: 07/29/2024
 Time: 10:15:52

EXTERNAL STANDARD INFORMATION

NOMINAL: 0.100
 TARGET AT 29.42: 0.098
 LOT #: AG333401
 EXPIRATION: 11/30/2025
 TANK PRESSURE: 1114 psi

BLANK TEST	0.000	10:17
INTERNAL STANDARD	VERIFIED	10:17
EXTERNAL STANDARD	0.097	10:17
BLANK TEST	0.000	10:18
EXTERNAL STANDARD	0.097	10:18
BLANK TEST	0.000	10:19
EXTERNAL STANDARD	0.097	10:19
BLANK TEST	0.000	10:20
EXTERNAL STANDARD	0.097	10:20
BLANK TEST	0.000	10:21
EXTERNAL STANDARD	0.097	10:21
BLANK TEST	0.000	10:22

Average = 0.0970
 Std Dev = 0.0000

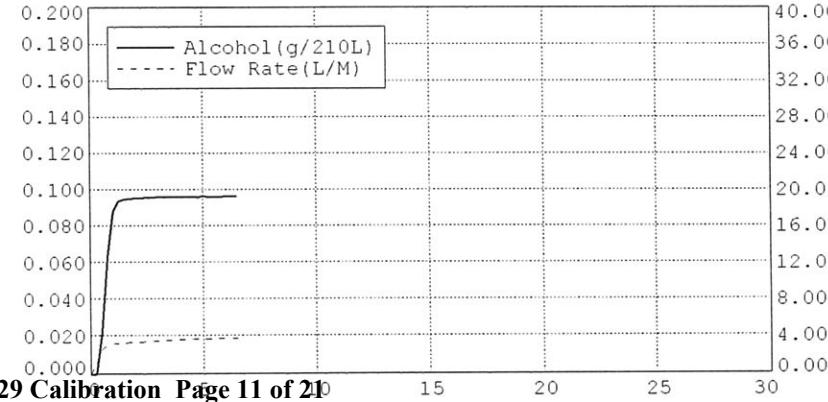
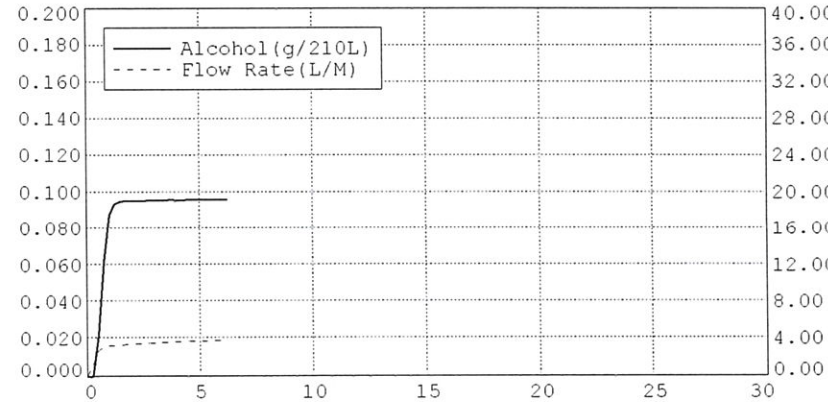
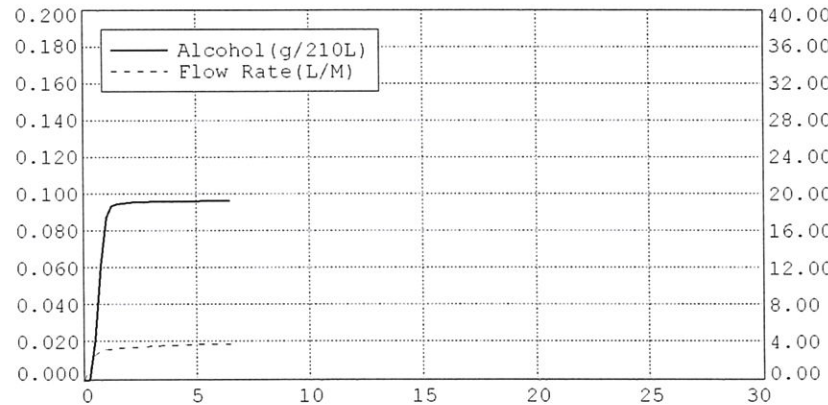
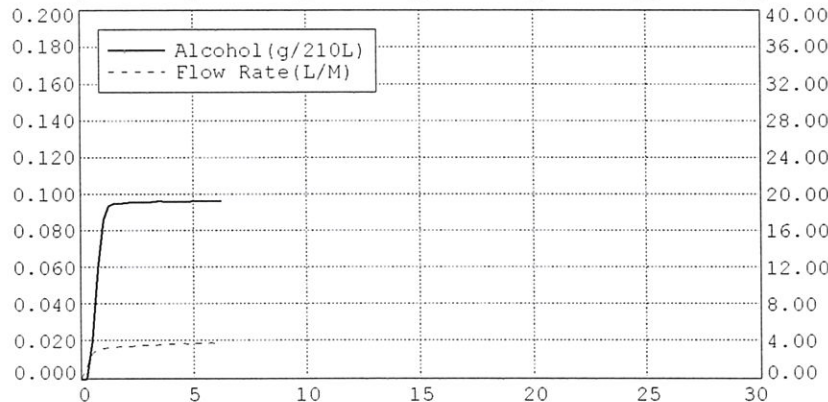
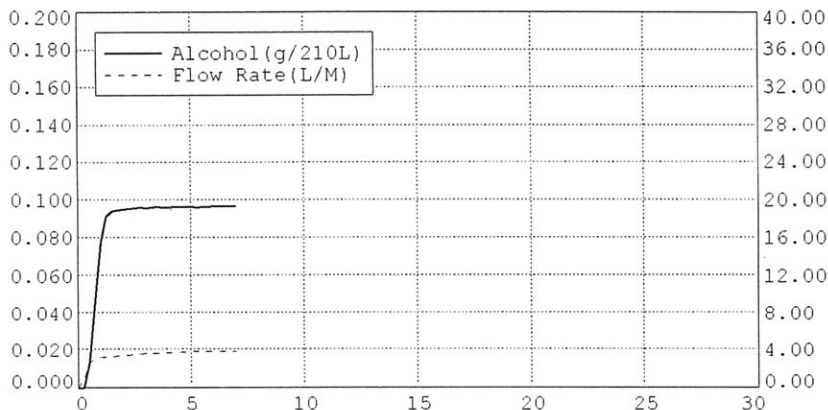

LINEARITY CHECK: Control Test 5

Alaska Department of Public Safety
 DATAMASTER dmt: 100696

Date: 07/29/2024
 Time: 10:24:29

EXTERNAL STANDARD INFORMATION

NOMINAL: 0.150
 TARGET AT 29.42: 0.147
 LOT #: AG332004
 EXPIRATION: 11/16/2025
 TANK PRESSURE: 643 psi

BLANK TEST	0.000	10:25
INTERNAL STANDARD	VERIFIED	10:25
EXTERNAL STANDARD	0.142	10:26
BLANK TEST	0.000	10:27
EXTERNAL STANDARD	0.142	10:27
BLANK TEST	0.000	10:28
EXTERNAL STANDARD	0.142	10:28
BLANK TEST	0.000	10:29
EXTERNAL STANDARD	0.142	10:29
BLANK TEST	0.000	10:30
EXTERNAL STANDARD	0.142	10:30
BLANK TEST	0.000	10:31

Average = 0.1420
 Std Dev = 0.0000

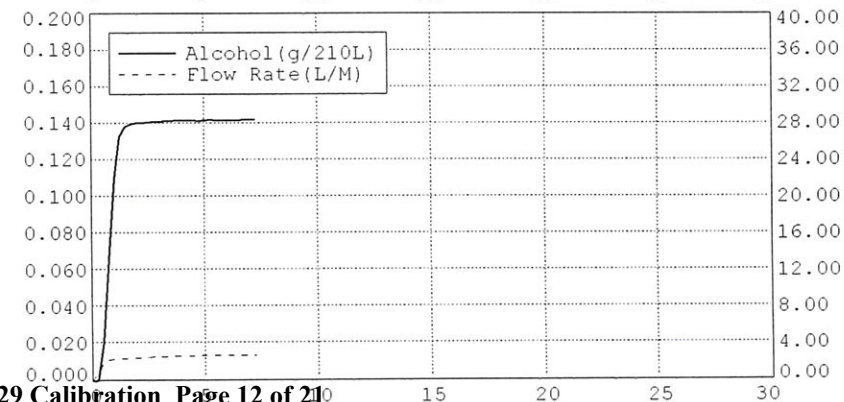
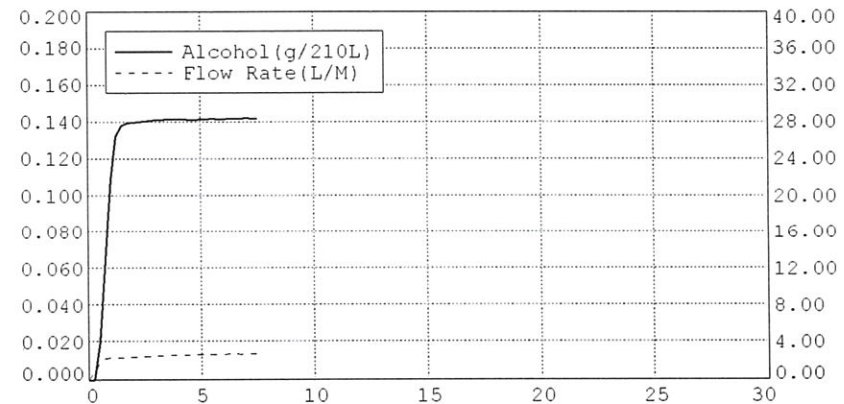
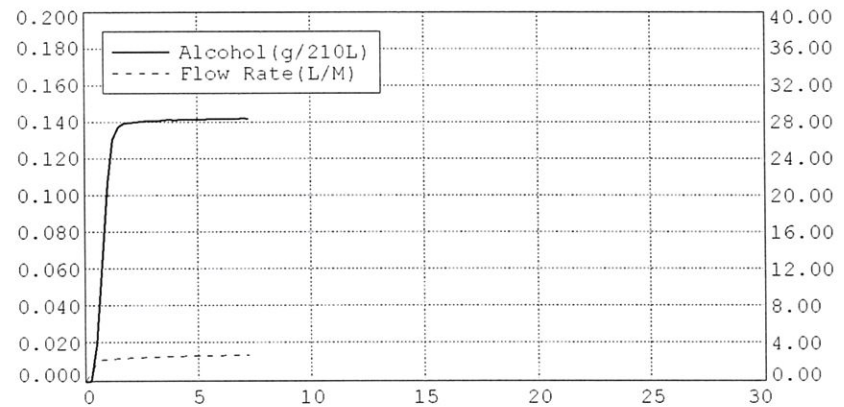
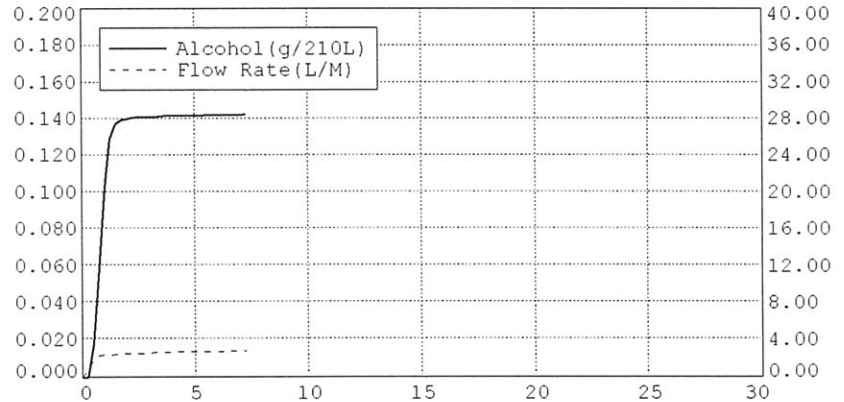
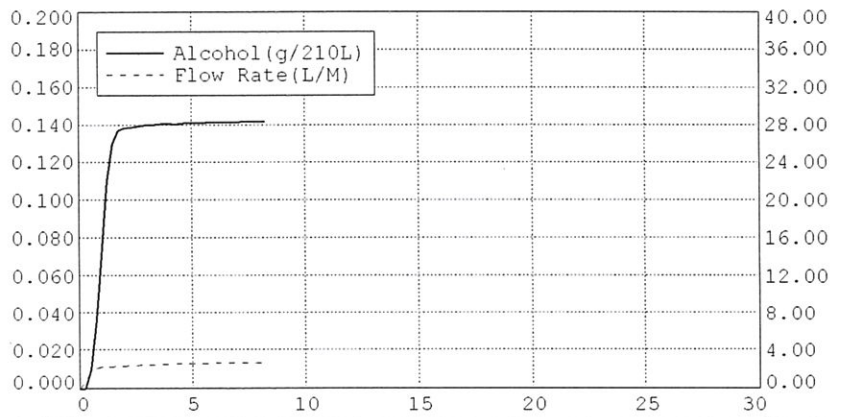

LINEARITY CHECK: Control Test 6

Alaska Department of Public Safety
 DATAMASTER dmt: 100696

Date: 07/29/2024
 Time: 10:33:05

EXTERNAL STANDARD INFORMATION

NOMINAL: 0.300
 TARGET AT 29.42: 0.295
 LOT #: AG327804
 EXPIRATION: 10/05/2025
 TANK PRESSURE: 299 psi

BLANK TEST	0.000	10:34
INTERNAL STANDARD	VERIFIED	10:34
EXTERNAL STANDARD	0.289	10:34
BLANK TEST	0.000	10:35
EXTERNAL STANDARD	0.288	10:35
BLANK TEST	0.000	10:36
EXTERNAL STANDARD	0.288	10:37
BLANK TEST	0.000	10:38
EXTERNAL STANDARD	0.288	10:38
BLANK TEST	0.000	10:39
EXTERNAL STANDARD	0.288	10:39
BLANK TEST	0.000	10:40

Average = 0.2882
 Std Dev = 0.0004

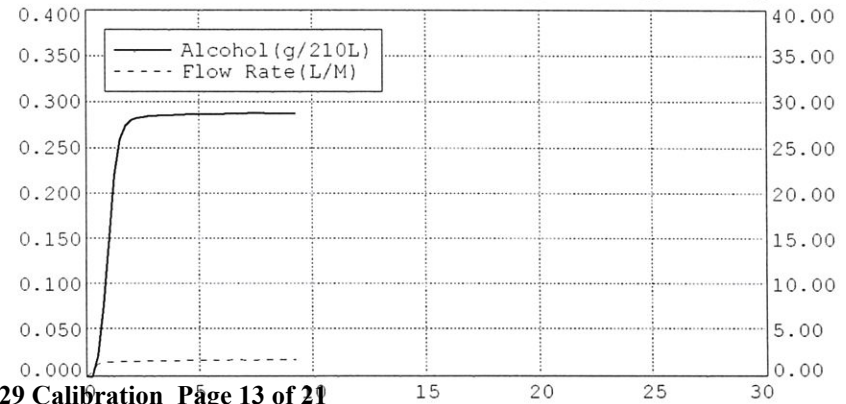
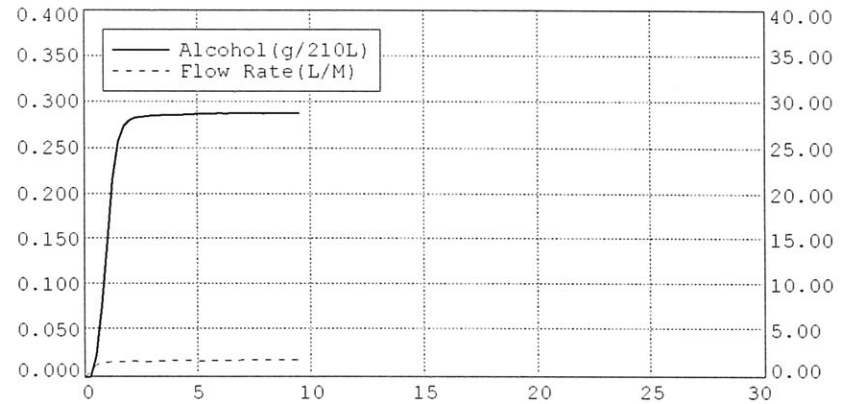
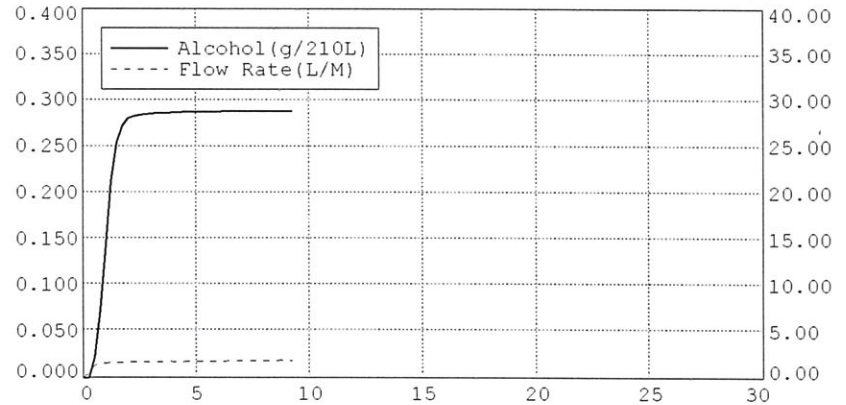
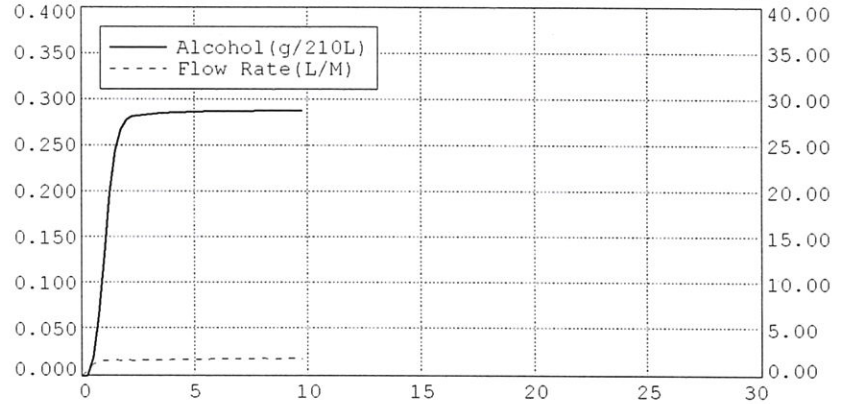
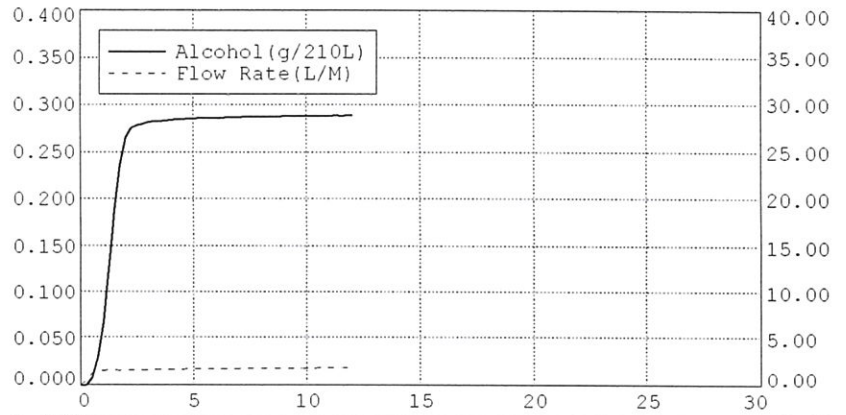

SUBJECT TEST

Alaska Department of Public Safety

DATAMASTER dmt: 100696

Date: 07/29/2024
Time: 10:55:10

SUBJECT NAME:
TEST TEST
LICENSE #: XXX

OPERATOR NAME:
MEGAN CARLOCK
OPERATOR'S #: 10747

DEPT/AGENCY:
INCOMPLETE
CASE/REPORT: XXX
TEST TYPE: TEST

EXTERNAL STANDARD INFORMATION

NOMINAL: 0.080
TARGET AT 29.43: 0.079
LOT #: AG335202
EXPIRATION: 12/18/2025

DIAGNOSTIC CHECK PASSED 10:56
BLANK TEST 0.000 10:56
INTERNAL STANDARD VERIFIED 10:56
EXTERNAL STANDARD 0.078 10:56
BLANK TEST 0.000 10:57
SUBJECT SAMPLE INCOMPLETE 11:00

MWC

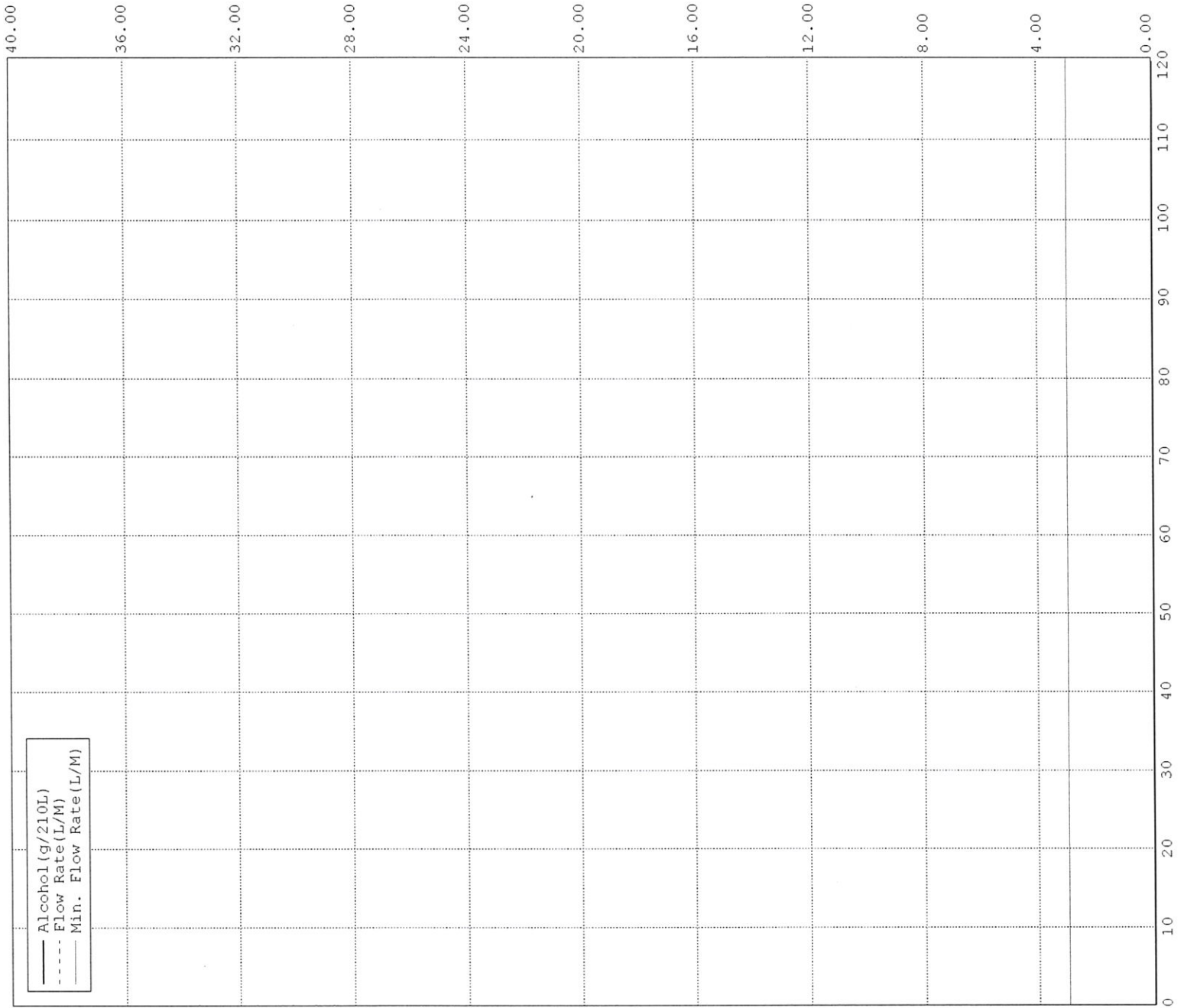

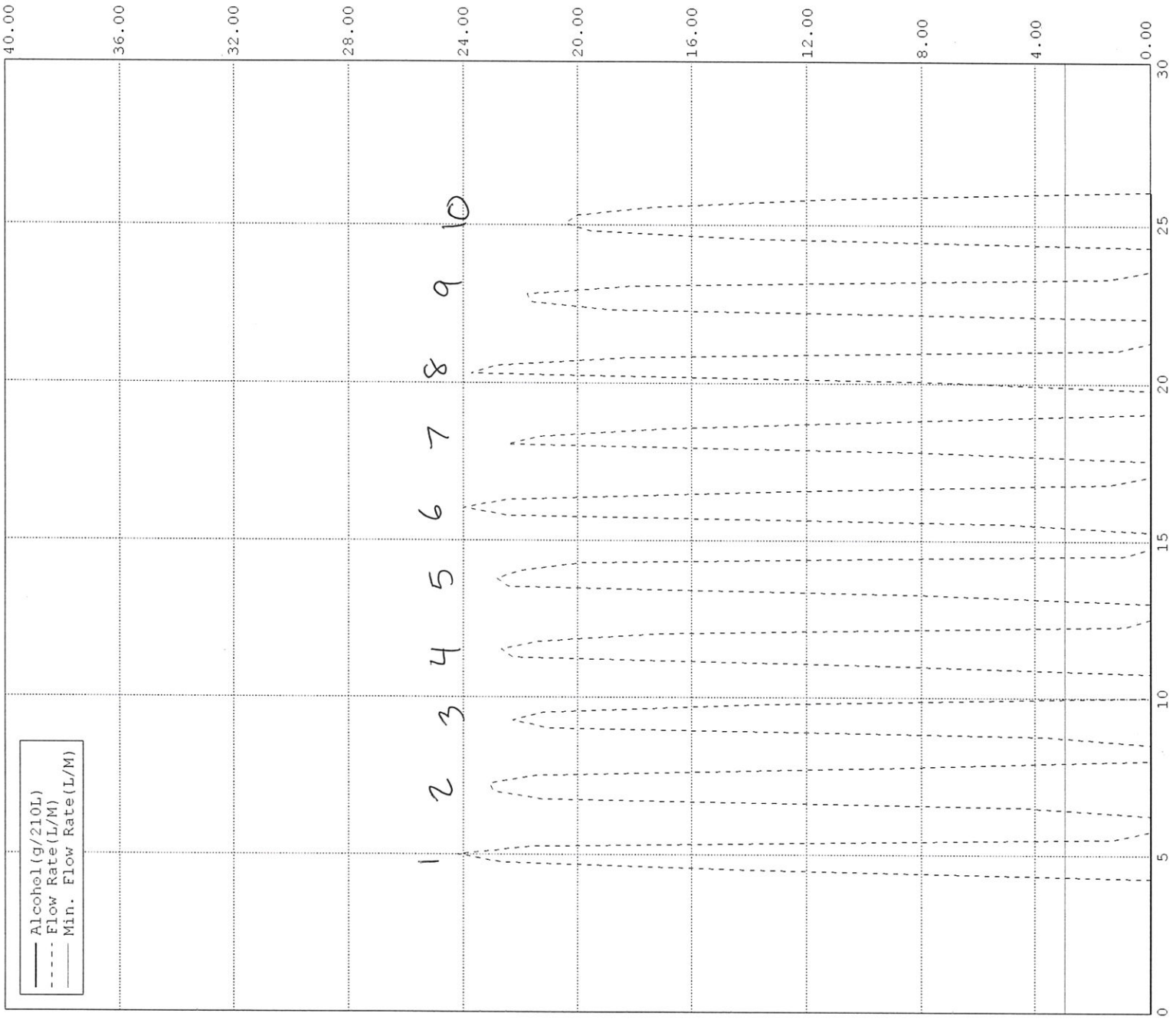

SUBJECT TEST

 Alaska Department of Public Safety
 DATAMASTER dmt: 100696

 Date: 07/29/2024
 Time: 11:04:39

SUBJECT NAME:
 TEST TEST
 LICENSE #: XXX

OPERATOR NAME:
 MEGAN CARLOCK
 OPERATOR'S #: 10747

DEPT/AGENCY:
 MAXIMUM ATTEMPTS EXCEEDED
 CASE/REPORT: XXX
 TEST TYPE: TEST

EXTERNAL STANDARD INFORMATION
 NOMINAL: 0.080
 TARGET AT 29.43: 0.079
 LOT #: AG335202
 EXPIRATION: 12/18/2025

DIAGNOSTIC CHECK	PASSED	11:05
BLANK TEST	0.000	11:05
INTERNAL STANDARD	VERIFIED	11:05
EXTERNAL STANDARD	0.078	11:06
BLANK TEST	0.000	11:07
SUBJECT SAMPLE	XXX	11:07

Maximum Attempts Exceeded

MNC

100696 2024.07.29 Calibration Page 15 of 21

SUBJECT TEST

Alaska Department of Public Safety

DATAMASTER dmt: 100696

Date: 07/29/2024

Time: 11:11:20

SUBJECT NAME:

TEST TEST

LICENSE #: XXX

OPERATOR NAME:

MEGAN CARLOCK

OPERATOR'S #: 10747

DEPT/AGENCY:

RFI

CASE/REPORT: XXX

TEST TYPE: TEST

EXTERNAL STANDARD INFORMATION

NOMINAL: 0.080

TARGET AT 29.43: 0.079

LOT #: AG335202

EXPIRATION: 12/18/2025

DIAGNOSTIC CHECK

BLANK TEST

INTERNAL STANDARD

EXTERNAL STANDARD

BLANK TEST

PASSED 11:12

0.000

11:12

VERIFIED 11:12

0.078

11:12

0.000

11:13

RFI DETECTED

MNJC

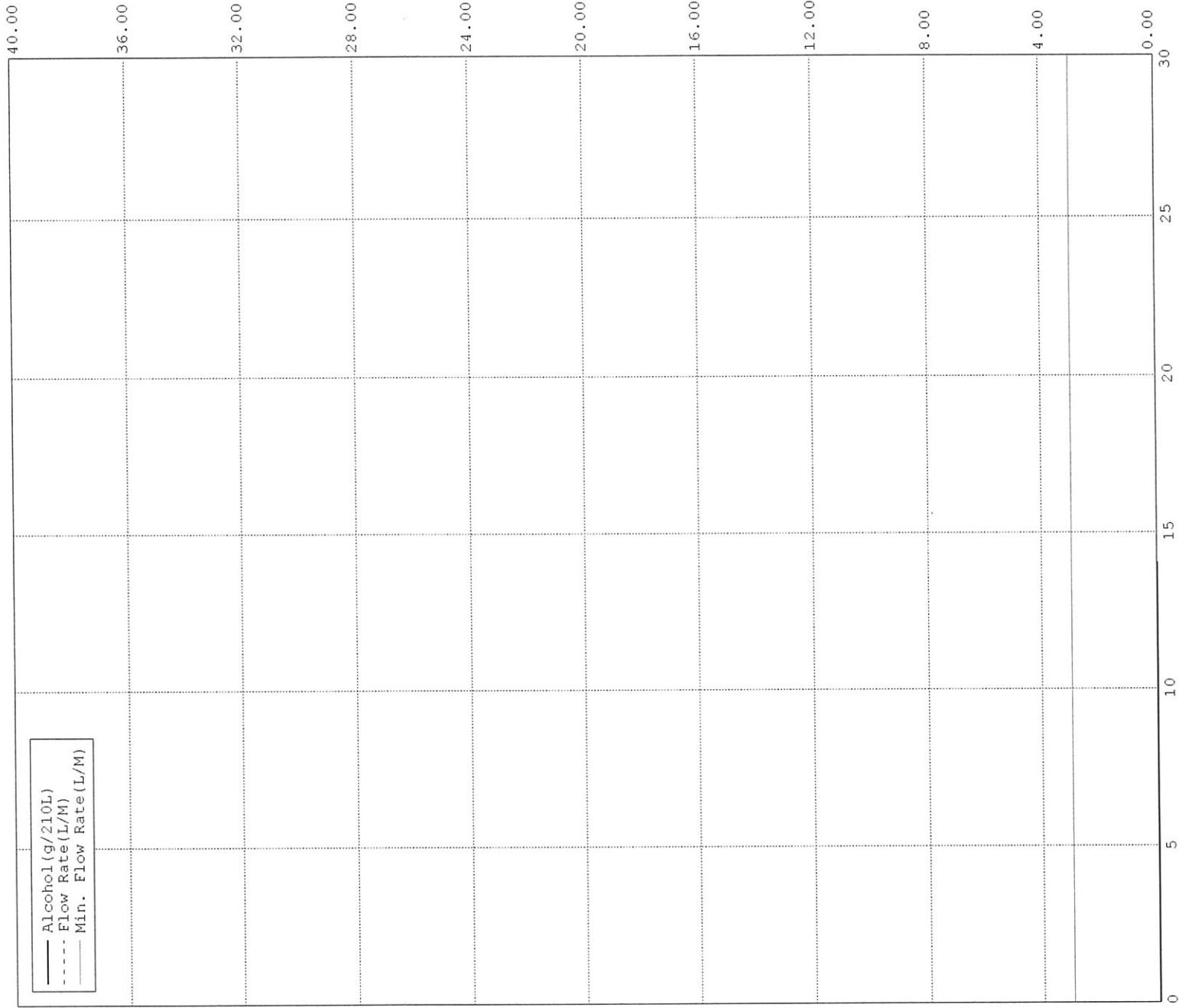

SUBJECT TEST

Alaska Department of Public Safety

DATAMASTER dmt: 100696

Date: 07/29/2024

Time: 11:20:10

SUBJECT NAME:

TEST TEST

LICENSE #: XXX

OPERATOR NAME:

MEGAN CARLOCK

OPERATOR'S #: 10747

DEPT/AGENCY:

INVALID

CASE/REPORT: XXX

TEST TYPE: TEST

EXTERNAL STANDARD INFORMATION

NOMINAL: 0.080

TARGET AT 29.43: 0.079

LOT #: AG335202

EXPIRATION: 12/18/2025

DIAGNOSTIC CHECK

PASSED 11:21

0.000 11:21

INTERNAL STANDARD

VERIFIED 11:21

0.077 11:21

EXTERNAL STANDARD

0.000 11:22

INVALID 11:22

SUBJECT SAMPLE

MWJC

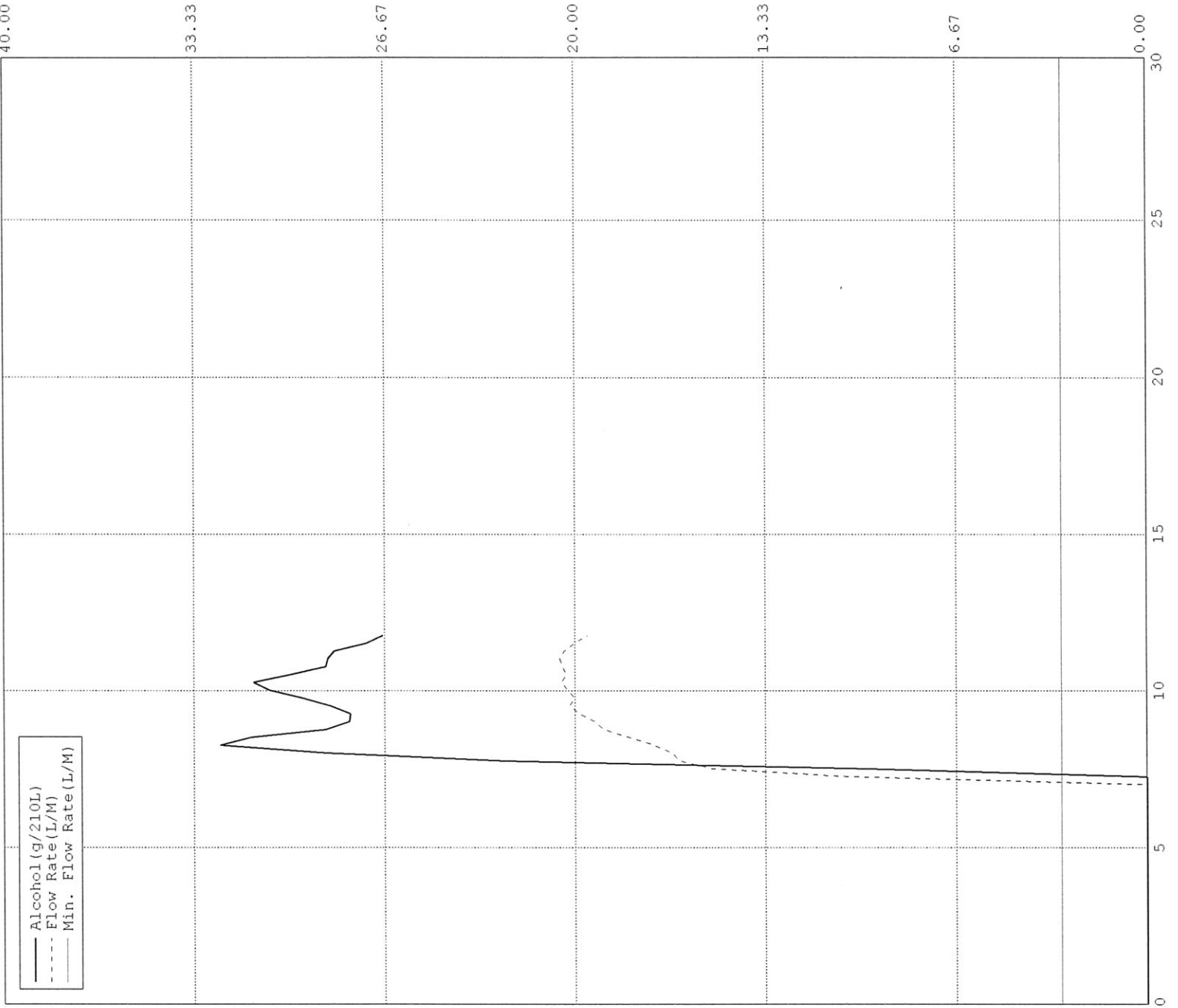

SUBJECT TEST

Alaska Department of Public Safety

DATAMASTER dmt: 100696

Date: 07/29/2024
Time: 11:52:49

SUBJECT NAME:
TEST TEST
LICENSE #: XXX

OPERATOR NAME:
MEGAN CARLOCK
OPERATOR'S #: 10747

DEPT/AGENCY:
INTERFERENCE - ACETONE
CASE/REPORT: XXX
TEST TYPE: TEST

EXTERNAL STANDARD INFORMATION

NOMINAL: 0.080
TARGET AT 29.43: 0.079
LOT #: AG335202
EXPIRATION: 12/18/2025

DIAGNOSTIC CHECK	PASSED	11:53
BLANK TEST	0.000	11:53
INTERNAL STANDARD	VERIFIED	11:54
Xq = 0.106 (0.08%)		
EXTERNAL STANDARD	0.077	11:54
X[1] = 0.0774 (0.0014) (0.0018)		
BLANK TEST	0.000	11:55
SUBJECT SAMPLE	XXX	11:55
X[1] = 0.1003 (-0.0147) (0.0022)		

Interference Detected

Filter 2 Average: 0.0011

Filter 3 Average: 0.0016
MNC 7/29/24

MNC

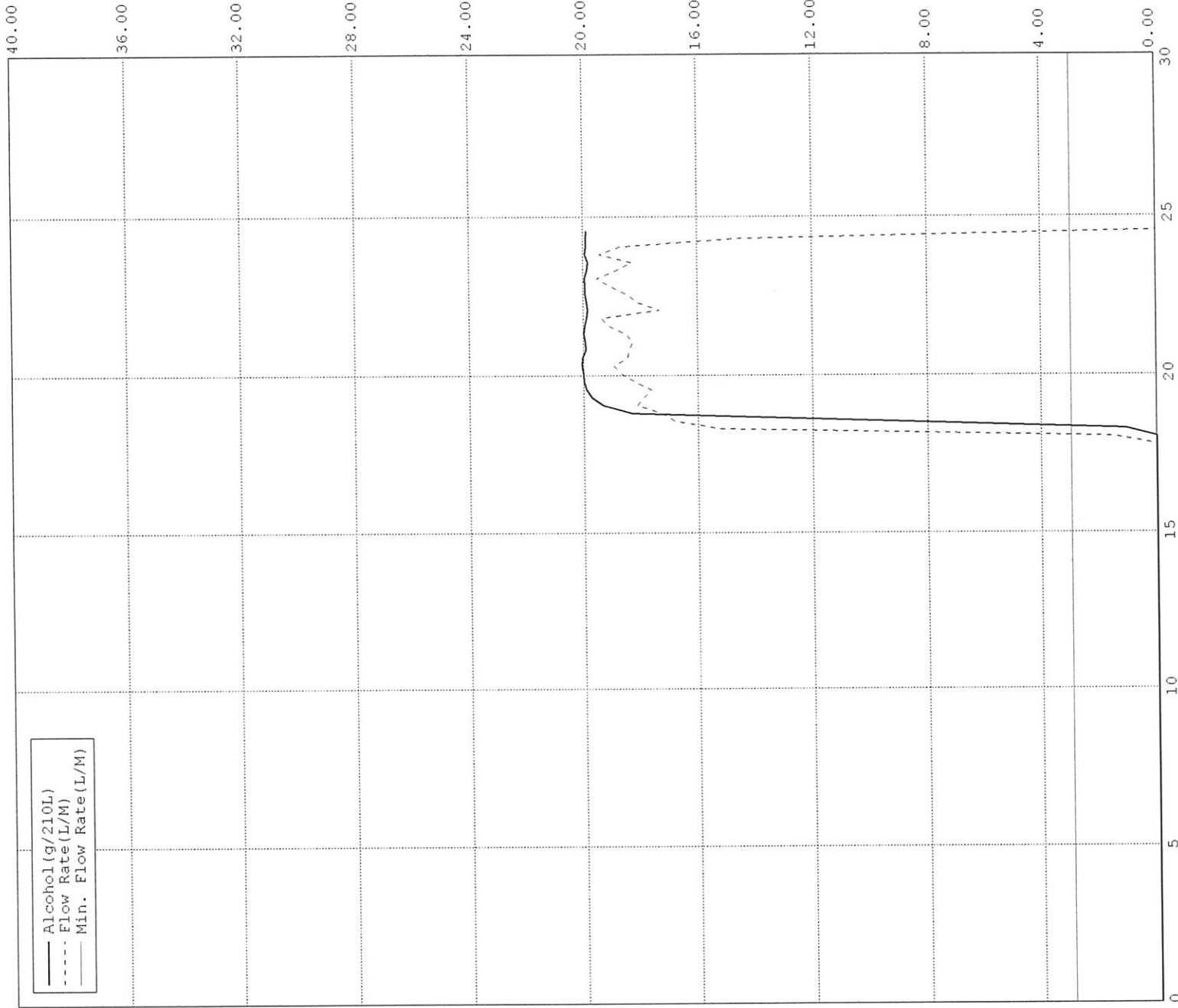

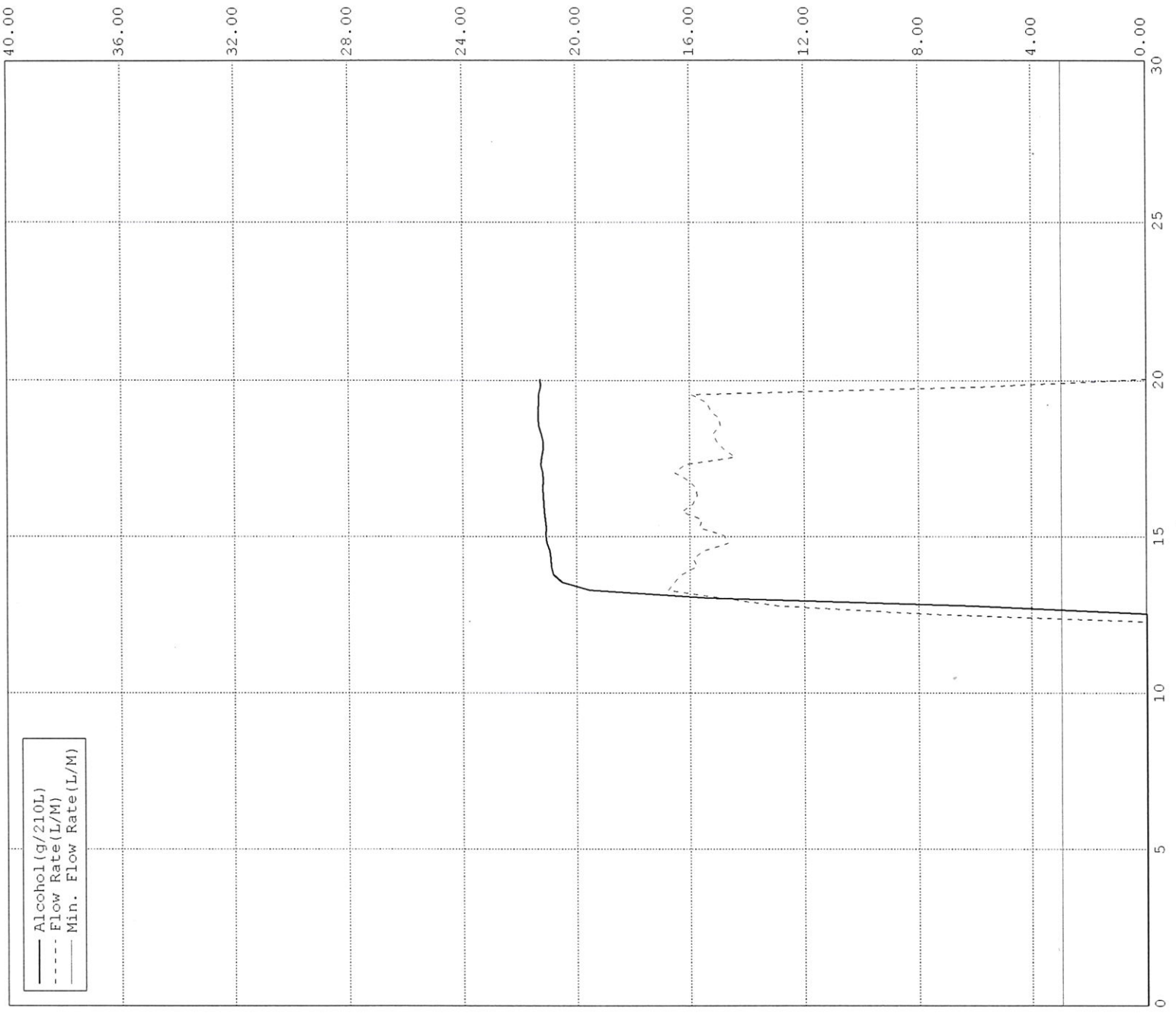

SUBJECT TEST

 Alaska Department of Public Safety
 DATAMASTER dmt: 100696

 Date: 07/29/2024
 Time: 11:47:06

SUBJECT NAME:
 TEST TEST
 LICENSE #: XXX

OPERATOR NAME:
 MEGAN CARLOCK
 OPERATOR'S #: 10747

DEPT/AGENCY:
 INTERFERENCE - IPA
 CASE/REPORT: XXX
 TEST TYPE: TEST

EXTERNAL STANDARD INFORMATION
 NOMINAL: 0.080
 TARGET AT 29.43: 0.079
 LOT #: AG335202
 EXPIRATION: 12/18/2025

DIAGNOSTIC CHECK PASSED 11:48
 BLANK TEST 0.000 11:48
 INTERNAL STANDARD VERIFIED 11:48
 Xg = 0.107 (0.99%)
 EXTERNAL STANDARD 0.078 11:48
 X[1] = 0.0779 (0.0014) (0.0023)
 BLANK TEST 0.000 11:49
 SUBJECT SAMPLE XXX 11:49
 X[1] = 0.1073 (-0.0232) (0.0010)

Interference Detected

MNC

100696 2024.07.29 Calibration Page 19 of 21

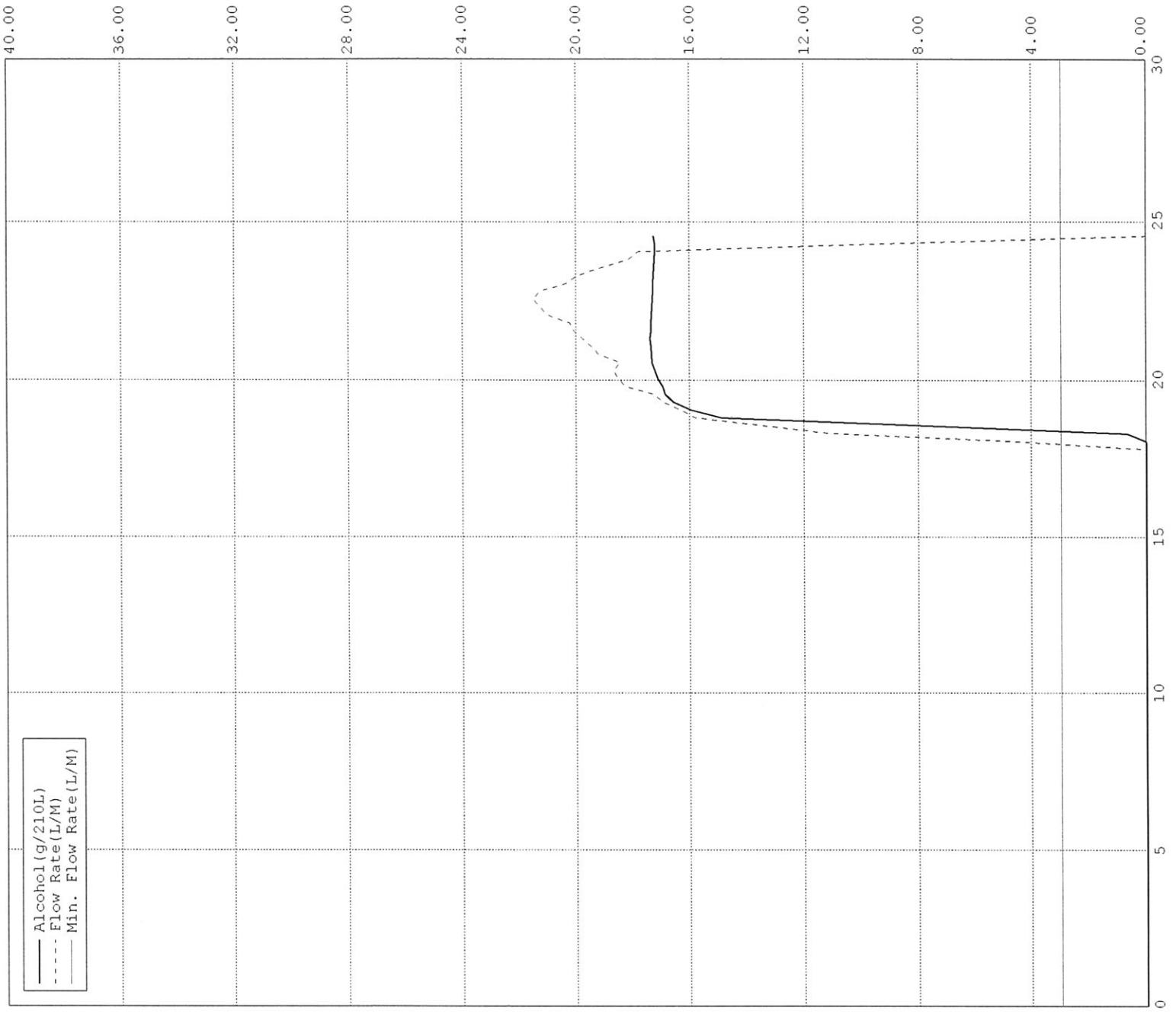

SUBJECT TEST

 Alaska Department of Public Safety
 DATAMASTER dmt: 100696

 Date: 07/29/2024
 Time: 11:40:36

SUBJECT NAME:
 TEST TEST
 LICENSE #: XXX

OPERATOR NAME:
 MEGAN CARLOCK
 OPERATOR'S #: 10747

DEPT/AGENCY:
 INTERFERENCE - NEGATIVE
 CASE/REPORT: XXX
 TEST TYPE: TEST

EXTERNAL STANDARD INFORMATION
 NOMINAL: 0.080
 TARGET AT 29.43: 0.079
 LOT #: AG335202
 EXPIRATION: 12/18/2025

DIAGNOSTIC CHECK	PASSED	11:41
BLANK TEST	0.000	11:41
INTERNAL STANDARD	VERIFIED	11:41
Xg = 0.106 (0.25%)		
EXTERNAL STANDARD	0.077	11:42
X[1] = 0.0771 (0.0002) (0.0013)		
BLANK TEST	0.000	11:43
SUBJECT SAMPLE (Vol=1.91L)	0.087	11:43
X[1] = 0.0871 (0.0003) (0.0003)		
BLANK TEST	0.000	11:44
EXTERNAL STANDARD	0.077	11:44
X[1] = 0.0767 (0.0014) (0.0011)		
BLANK TEST	0.000	11:45

MWC

100696 2024.07.29 Calibration Page 20 of 21

SUBJECT TEST

Alaska Department of Public Safety
DATAMASTER dmt: 100696

Date: 07/29/2024
Time: 12:09:08

SUBJECT NAME:
TEST TEST
LICENSE #: XXX

OPERATOR NAME:
MEGAN CARLOCK
OPERATOR'S #: 10747

DEPT/AGENCY:
NON-DRINKING SUBJECT TEST
CASE/REPORT: XXX
TEST TYPE: TEST

EXTERNAL STANDARD INFORMATION
NOMINAL: 0.080
TARGET AT 29.42: 0.079
LOT #: AG335202
EXPIRATION: 12/18/2025

DIAGNOSTIC CHECK	PASSED	12:10
BLANK TEST	0.000	12:10
INTERNAL STANDARD	VERIFIED	12:10
EXTERNAL STANDARD	0.077	12:10
BLANK TEST	0.000	12:11
SUBJECT SAMPLE (Vol=2.74L)	0.000	12:11
BLANK TEST	0.000	12:12
EXTERNAL STANDARD	0.078	12:13
BLANK TEST	0.000	12:13

MWC

